



TECHNICAL HANDBOOK **SUBMERGED ARC WELDING**



**FLUXES AND WIRES FOR JOINING NON AND LOW-ALLOYED
STEELS, STAINLESS STEELS AND NICKEL-BASE ALLOYS.**



IT'S ALL HERE

A complete range of welding and cutting equipment, filler materials and accessories for any type of industry? We've got it.

The expertise and application experience to share with you? Absolutely. A worldwide network of sales offices and distributors to give you service and support wherever you are? Positive.

It's all here to help you boost your welding productivity. All from a single dependable source. From ESAB.

Visit us at esab.com

Contents

	page		page
Introduction to the SAW technical handbook	4	General information pages	57
Flux selection pages		Product documents	58
Flux selection by industry segment	5	The submerged arc welding process	59
Flux selection by parent material	6	SAW variants	62
Flux selection by classification	10	ICE™ technology	64
Flux selection by flux characteristics	13	Cored wires for submerged arc welding	65
Flux selection by wire type	14	Automation	66
Chemical composition of SAW wires	15	Fluxes	68
How to choose the right flux/wire combination	16	Neutral, active or alloying fluxes	69
		Weld metal alloying	69
		Hydrogen in ferritic weld metal	70
Product data pages		Global manufacturing	71
OK Flux 10.16	46	Production facility certificates	71
OK Flux 10.61	18	R&D and Central Laboratory	72
OK Flux 10.62	20	Welding Process Centre	72
Narrow gap welding - complete ESAB solution for repetitive fabrication of thick sections	23	SAW joint preparations	74
OK Flux 10.63	24	Trouble shooting guide	76
OK Flux 10.64	25	Handling equipment	78
OK Flux 10.69	26	High productivity packaging	79
OK Flux 10.70	27	A suitable spool for each application	80
OK Flux 10.71	28	Always the most productive delivery packaging	82
OK Flux 10.72	30	Full protection with no moisture absorption - BlockPac™	83
OK Flux 10.72 - wind towers, pressure vessels and general construction	32	Easy and efficient storage and handling of fluxes	84
OK Flux 10.74	33	Classification Standards	85
OK Flux 10.76	36	Approvals	94
OK Flux 10.77	34		
OK Flux 10.80	37		
OK Flux 10.81	38		
OK Flux 10.81 – For power generation, beams, automotive industry, general construction	40		
OK Flux 10.83	41		
OK Flux 10.87	42		
Overlap welds on thin material; also butt and fillet welds	43		
OK Flux 10.88	44		
Heavy mill scale - not all customers remove it from the weld area	45		
OK Flux 10.90	48		
The best flux for LNG applications	49		
OK Flux 10.92	50		
ESAB stainless flux package	51		
OK Flux 10.93	52		
OK Flux 10.94	54		
OK Flux 10.95	55		
OK Flux 10.99	56		

DISCLAIMER

Whilst all reasonable efforts have been made to ensure the accuracy of the information contained in this handbook at the time of going to press, ESAB gives no warranty with regard to its accuracy or completeness. It is the responsibility of the reader to check the accuracy of the information contained in this handbook, read product labels and equipment instructions and comply with current regulations. If the reader is in any doubt with regard to the proper use of any technology they should contact the manufacturer or obtain alternative expert advice. ESAB accepts no responsibility or liability for any injury, loss or damage incurred as a result of any use or reliance upon the information contained in this handbook.

Introduction to the SAW technical handbook

This technical handbook gives detailed information of the extensive range of ESAB consumables for joining materials with the submerged arc welding process, along with general information associated with this process. Consumables for cladding and hardfacing are described in other documents available from ESAB. This handbook consists of three main sections:

- The flux selection tables, page 5 - 16
- The product data pages, page 18 - 56
- The general information pages 57 - 84

The flux selection tables enable the correct flux to be chosen for various practical welding situations:

- by industry segment, page 5
- by parent material, page 6 - 9
- by flux/wire classification, page 10 - 12
- by flux characteristics, page 13
- by wire type and chemical composition, page 14 - 15

Page 16 gives a theoretical background for the choice of the most suitable flux/wire combination.

The product data pages give a comprehensive description of flux characteristics and application areas, and all relevant data on the flux and flux/wire combinations, including approvals.

Chemical composition, mechanical properties and other data are typical, unless otherwise stated. Only the main approval authorities are listed.

An extended overview of mechanical properties and a full list of approvals for each product may be given in the product data sheets (PDS) available from ESAB.

Certain products, with particularly beneficial properties, are discussed in detail on separate pages following the product data page of the flux in question.

The general information pages discuss the SAW process in detail - including its process variants, packaging and handling, ESAB as a global producer of SAW flux and wires and classification standards.

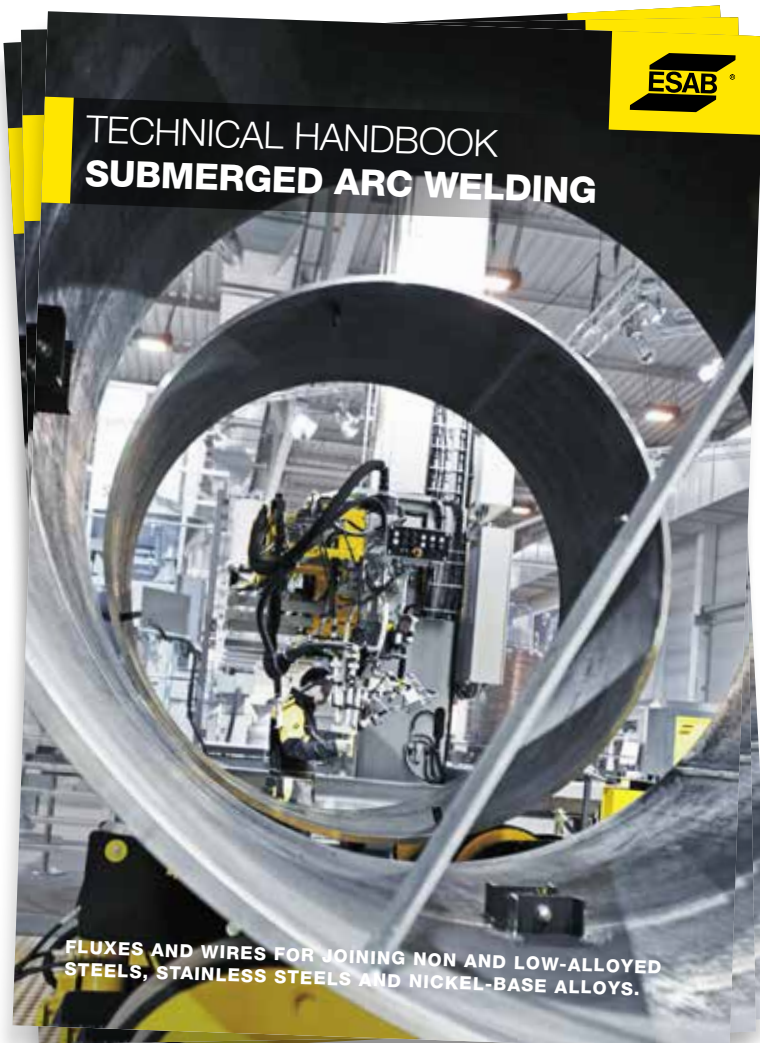

Flux selection by industry segment

		OK Flux 10.16	OK Flux 10.61	OK Flux 10.62	OK Flux 10.63	OK Flux 10.64	OK Flux 10.69	OK Flux 10.70	OK Flux 10.71	OK Flux 10.72	OK Flux 10.74	OK Flux 10.76	OK Flux 10.77	OK Flux 10.80	OK Flux 10.81	OK Flux 10.83	OK Flux 10.87	OK Flux 10.88	OK Flux 10.90	OK Flux 10.92	OK Flux 10.93	OK Flux 10.94	OK Flux 10.95	OK Flux 10.99
Segments	Applications																							
energy	wind towers								•	•														
	monopiles			•																				
	boilers	•	•	•		•		•	•	•				•	•	•		•	•	•	•		•	•
	membrane walls								•						•	•	•	•						
	turbines		•	•	•																			
	nuclear			•																		•		
pipemills	spiral (2- run)								•				•		•			•						
	longitudinal (2-run)										•		•						•		•			•
	multi run - longitudinal			•					•										•		•			•
pipelines	double-jointing		•	•					•										•		•			•
	valves, fittings			•					•										•		•			•
shipbuilding	butt welds			•				•	•			•			•			•						
	fillet welds			•				•	•			•			•			•						
	one-sided backing flux						•																	
	ship tanks for: LPG	•																	•	•	•			•
	LNG																		•		•			•
chemicals																		•		•	•	•	•	
offshore	jacket legs / top sides / decks			•																				
	process components	•																	•		•		•	•
transport	wheels								•						•	•	•							
	air compressor tanks																•							
	trucks								•						•			•						
	mobile cranes			•																				
	earth moving equipment								•						•			•			•			
	road construction equipment								•						•			•						
	trains								•						•			•						
	trailer beams								•						•	•	•	•						
civil construction	bridges		•	•					•						•			•			•	•		
	buildings		•	•					•						•			•			•	•		
	cranes		•	•					•						•			•						
	lamp posts															•	•							
	beams								•						•	•	•	•						
land-based storage tanks	oil								•									•						
	LPG	•																	•	•	•			•
	LNG																		•		•			•
	chemicals																		•		•		•	•
pressure vessels	vessels		•	•		•		•	•	•				•	•	•		•			•		•	
	gas bottles / air compressor tanks																•							
process industry	hydrocrackers			•	•																			
	pulp & paper	•																	•		•			•
	urea																				•			
clad restoration																			•	•				

Flux selection by parent material

Steel categories	Various flux-wire combinations, dependent on application, see product data pages																		
	OK Flux 10.61 / OK Autrod 12.24	OK Flux 10.61 / OK Autrod 12.32	OK Flux 10.61 / OK Autrod 12.40	OK Flux 10.61 / OK Autrod 13.10 SC	OK Flux 10.61 / OK Autrod 13.20 SC	OK Flux 10.62 / OK Autrod 12.22	OK Flux 10.62 / OK Autrod 12.24	OK Flux 10.62 / OK Autrod 12.32	OK Flux 10.62 / OK Autrod 12.34	OK Flux 10.62 / OK Autrod 12.40	OK Flux 10.62 / OK Autrod 13.10 SC	OK Flux 10.62 / OK Autrod 13.20 SC	OK Flux 10.62 / OK Autrod 13.24	OK Flux 10.62 / OK Autrod 13.27	OK Flux 10.62 / OK Autrod 13.40	OK Flux 10.62 / OK Autrod 13.43	OK Flux 10.62 / OK Autrod 13.49	OK Flux 10.62 / OK Tubrod 15.24S	OK Flux 10.62 / OK Tubrod 15.25S
Normal strength																			
ReL < 355 MPa	•					•		•							•			•	•
ReL ≥ 355 MPa	•					•		•		•					•			•	•
ReL ≥ 420 MPa	•					•		•		•			•		•			•	•
ReL ≥ 460 MPa								•		•			•		•			•	•
ReL ≥ 500 MPa									•	•			•		•				
High strength																			
ReL ≥ 550 Mpa															•				
ReL ≥ 620 MPa																•			
ReL ≥ 690 MPa																•			
Pipe steels																			
ReL = 241 - 448 MPa (B - X65)																			
ReL = 485 MPa (X70)																			
ReL = 552 MPa (X80)				•															
Low temperature																			
-40°C (≥ 47J)	•					•		•		•			•		•		•	•	•
-50°C (≥ 47J)						•		•		•			•		•		•	•	•
-60°C (≥ 47J)								•		•			•		•		•	•	•
-70°C (≥ 47J)										•			•		•		•	•	•
-80°C (≥ 47J)													•		•		•	•	•
Creep resistant																			
0.5% Mo				•						•									
1.25% Cr, 0.5% Mo					•							•							
2.25% Cr, 1% Mo						•							•						
2.25% Cr, 1% Mo, 0.25%V				•															
5% Cr, 0.5% Mo				•															
9% Cr, 1% MoVNB																			
Weather resistant																			
Ni, Cu, Cr-alloyed																			

Steel categories

	OK Flux 10.16 / OK Autrod NiCr-3	OK Flux 10.16 / OK Autrod NiCrMo-3	OK Flux 10.16 / OK Autrod NiCrMo-13	OK Flux 10.90 / OK Autrod 310	OK Flux 10.90 / OK Autrod NiCr-3	OK Flux 10.90 / OK Autrod NiCrMo-3	OK Flux 10.90 / OK Autrod NiCrMo-4	OK Flux 10.90 / OK Autrod NiCrMo-13	OK Flux 10.92 / OK Autrod 308L	OK Flux 10.92 / OK Autrod 309L	OK Flux 10.92 / OK Autrod 316L	OK Flux 10.92 / OK Autrod 318	OK Flux 10.92 / OK Autrod 347	OK Flux 10.92 / OK Autrod 16.97	OK Flux 10.93 / OK Autrod 308L	OK Flux 10.93 / OK Autrod 308H	OK Flux 10.93 / OK Autrod 309L	OK Flux 10.93 / OK Autrod 309MoL	OK Flux 10.93 / OK Autrod 310MoL	OK Flux 10.93 / OK Autrod 312
Stainless																				
302									•						•					
304									•						•					
304L									•						•					
304LN									•						•					
307																				
308									•						•					
308L									•						•					
308H																•				
309																	•			
309L																	•			
309S																	•			
309Mo																		•		
309LMo																		•		
310				•																
310S				•																
312																				•
316											•	•								
316L											•	•							•	
316Ti											•	•								
316LN											•	•								
316H																				
317																				
317L																				
318												•								
321												•	•							
347													•							
347L													•							
385		•						•												
403									•						•					
410										•							•			
410NiMo																				
420															•					
430															•					
430Nb													•	•	•					
446				•																
904L																				
2209																				
2507																				
CMn/SS				•													•	•	•	•
Nickel base																				
Alloy 600	•				•			•												
Alloy 625		•				•														
Alloy 686			•																	
Alloy 800	•				•			•												
Alloy 800H	•				•			•												
Alloy 825		•				•														
Cryogenic																				
≤ -150°C						•	•		•		•				•					

Flux selection by classification

Classifications according to EN

EN	Product / combination * Flux	Wire
S 35 A AR S1	OK Flux 10.87	OK Autrod 12.10
S 35 2 FB S1	OK Flux 10.61	OK Autrod 12.10
S 35 4 AB S1	OK Flux 10.71	OK Autrod 12.10
S 38 Z AR S1	OK Flux 10.83	OK Autrod 12.10
S 38 0 CS S1	OK Flux 10.80	OK Autrod 12.10
S 38 0 AR S1	OK Flux 10.88	OK Autrod 12.10
S 38 4 FB S2Si	OK Flux 10.61	OK Autrod 12.22
S 38 4 AB S2	OK Flux 10.71	OK Autrod 12.20
S 38 4 AB S2Si	OK Flux 10.71	OK Autrod 12.22
S 38 4 AB S2	OK Flux 10.77	OK Autrod 12.20
S 38 4 AB S2Si	OK Flux 10.77	OK Autrod 12.22
S 38 5 FB S2Si	OK Flux 10.62	OK Autrod 12.22
S 38 5 AB S2	OK Flux 10.72	OK Autrod 12.20
S 38 5 AB S2Si	OK Flux 10.72	OK Autrod 12.22
S 42 Z AR S2Si	OK Flux 10.83	OK Autrod 12.22
S 42 A AR S1	OK Flux 10.81	OK Autrod 12.10
S 42 A AR S2	OK Flux 10.87	OK Autrod 12.20
S 42 A AR S2Si	OK Flux 10.87	OK Autrod 12.22
S 42 0 CS S2	OK Flux 10.80	OK Autrod 12.20
S 42 2 FB S2Mo	OK Flux 10.61	OK Autrod 12.24
S 42 2 AB T3	OK Flux 10.71	OK Tubrod 14.00S
S 42 2 AR S2	OK Flux 10.88	OK Autrod 12.20
S 42 2 AR S2Si	OK Flux 10.88	OK Autrod 12.22
S 42 3 AB S1	OK Flux 10.70	OK Autrod 12.10
S 42 3 AB S1	OK Flux 10.76	OK Autrod 12.10
S 42 4 FB S2Ni1	OK Flux 10.62	OK Autrod 13.21
S 42 4 AB T3	OK Flux 10.71	OK Tubrod 15.00S
S 42 4 AB S2	OK Flux 10.74	OK Autrod 12.20
S 42 4 AB S2Si	OK Flux 10.74	OK Autrod 12.22
S 42 5 FB S3Si	OK Flux 10.61	OK Autrod 12.32
S 46 0 AR S2	OK Flux 10.81	OK Autrod 12.20
S 46 2 AB S2Mo	OK Flux 10.71	OK Autrod 12.24
S 46 2 AB S2Mo	OK Flux 10.74	OK Autrod 12.24
S 46 2 AB S2Mo	OK Flux 10.77	OK Autrod 12.24

EN	Product / combination * Flux	Wire
S 46 3 FB S4	OK Flux 10.61	OK Autrod 12.40
S 46 3 FB S2Ni1Cu	OK Flux 10.61	OK Autrod 13.36
S 46 3 AB S2	OK Flux 10.70	OK Autrod 12.20
S 46 3 AB S3	OK Flux 10.71	OK Autrod 12.30
S 46 3 AB S2Ni1Cu	OK Flux 10.71	OK Autrod 13.36
S 46 3 AB S2Mo	OK Flux 10.72	OK Autrod 12.24
S 46 4 FB S2Mo	OK Flux 10.62	OK Autrod 12.24
S 46 4 AB S3Si	OK Flux 10.71	OK Autrod 12.32
S 46 5 AB S2Ni2	OK Flux 10.71	OK Autrod 13.27
S 46 6 FB S3Si	OK Flux 10.62	OK Autrod 12.32
S 46 6 AB S2Ni2	OK Flux 10.72	OK Autrod 13.27
S 46 7 FB S2Ni2	OK Flux 10.62	OK Autrod 13.27
S 46 8 FB S2Ni3	OK Flux 10.62	OK Autrod 13.49
S 50 A AR S2Si	OK Flux 10.81	OK Autrod 12.22
S 50 A AR S2Mo	OK Flux 10.81	OK Autrod 12.24
S 50 A AR S2Ni1Cu	OK Flux 10.81	OK Autrod 13.36
S 50 0 AB S2Mo	OK Flux 10.70	OK Autrod 12.24
S 50 0 AR S3	OK Flux 10.81	OK Autrod 12.30
S 50 2 AB S3Mo	OK Flux 10.74	OK Autrod 12.34
S 50 3 AB S3Mo	OK Flux 10.71	OK Autrod 12.34
S 50 3 AB S3Mo	OK Flux 10.77	OK Autrod 12.34
S 50 4 FB S3Mo	OK Flux 10.62	OK Autrod 12.34
S 50 4 FB S4	OK Flux 10.62	OK Autrod 12.40
S 50 4 AB S3Ni1Mo0,2	OK Flux 10.71	OK Autrod 13.24
S 50 6 FB S3Ni1Mo0,2	OK Flux 10.62	OK Autrod 13.24
S 55 6 FB S3Ni1Mo	OK Flux 10.62	OK Autrod 13.40
S 69 6 FB S3Ni2,5CrMo	OK Flux 10.62	OK Autrod 13.43
S S CrMo1 FB (PWHT)	OK Flux 10.61	OK Autrod 13.10 SC
S S CrMo1 FB (PWHT)	OK Flux 10.62	OK Autrod 13.10 SC
S S CrMo1 FB (PWHT)	OK Flux 10.63	OK Autrod 13.10 SC
S S CrMo2 FB (PWHT)	OK Flux 10.62	OK Autrod 13.20 SC
S S CrMo2 FB (PWHT)	OK Flux 10.63	OK Autrod 13.20 SC

* Sorted by strength then toughness

Classifications according to AWS (as welded)

AWS As welded (A)	Product / combination * Flux	Wire
not applicable	OK Flux 10.61	OK Autrod 12.10
F6AZ-EL12	OK Flux 10.87	OK Autrod 12.10
F6AZ-EL12	OK Flux 10.88	OK Autrod 12.10
F6A4-EL12	OK Flux 10.71	OK Autrod 12.10
F7AZ-EL12	OK Flux 10.81	OK Autrod 12.10
F7AZ-EM12K	OK Flux 10.81	OK Autrod 12.22
F7AZ-EL12	OK Flux 10.83	OK Autrod 12.10
F7AZ-EM12K	OK Flux 10.83	OK Autrod 12.22
F7AZ-EM12	OK Flux 10.87	OK Autrod 12.20
F7AZ-EM12K	OK Flux 10.87	OK Autrod 12.22
F7A0-EM12	OK Flux 10.81	OK Autrod 12.20
F7A0-EM12	OK Flux 10.88	OK Autrod 12.20
F7A0-EM12K	OK Flux 10.88	OK Autrod 12.22
F7A2-EM12	OK Flux 10.70	OK Autrod 12.20
F7A2-EC1	OK Flux 10.71	OK Tubrod 14.00S
F7A2-EL12	OK Flux 10.80	OK Autrod 12.10
F7A2-EM12	OK Flux 10.80	OK Autrod 12.20
F7A2-EM12K	OK Flux 10.80	OK Autrod 12.22
F7A4-EA2-A2	OK Flux 10.61	OK Autrod 12.24
F7A4-EL12	OK Flux 10.70	OK Autrod 12.10
F7A4-EM12	OK Flux 10.71	OK Autrod 12.20
F7A4-EC1	OK Flux 10.71	OK Tubrod 15.00S
F7A4-EL12	OK Flux 10.76	OK Autrod 12.10
F7A4-EM12	OK Flux 10.77	OK Autrod 12.20
F7A5-EM12K	OK Flux 10.71	OK Autrod 12.22
F7A5-EH12K	OK Flux 10.71	OK Autrod 12.32
F7A5-EM12K	OK Flux 10.77	OK Autrod 12.22
F7A6-EH12K	OK Flux 10.61	OK Autrod 12.32
F7A6-EH14	OK Flux 10.61	OK Autrod 12.40
F7A6-EH14	OK Flux 10.62	OK Autrod 12.40
F7A6-ENi1-Ni1	OK Flux 10.62	OK Autrod 13.21
F7A6-EM12	OK Flux 10.74	OK Autrod 12.20
F7A6-EM12K	OK Flux 10.74	OK Autrod 12.22
F7A8-EM12K	OK Flux 10.61	OK Autrod 12.22
F7A8-EM12K	OK Flux 10.62	OK Autrod 12.22

AWS As welded (A)	Product / combination * Flux	Wire
F7A8-EH12K	OK Flux 10.62	OK Autrod 12.32
F7A8-EC-Ni2	OK Flux 10.62	OK Tubrod 15.25S
F7A8-EM12	OK Flux 10.72	OK Autrod 12.20
F7A8-EM12K	OK Flux 10.72	OK Autrod 12.22
F7A10-ENi2-Ni2	OK Flux 10.62	OK Autrod 13.27
F8A2-EA2-A4	OK Flux 10.71	OK Autrod 12.24
F8A2-EG-G	OK Flux 10.71	OK Autrod 13.36
F8A2-EA2-A4	OK Flux 10.74	OK Autrod 12.24
F8A4-EA4-A3	OK Flux 10.71	OK Autrod 12.34
F8A4-EA2-A2	OK Flux 10.77	OK Autrod 12.24
F8A4-EA4-A4	OK Flux 10.77	OK Autrod 12.34
F8A5-ENi6-Ni6	OK Flux 10.71	OK Autrod 13.24
F8A5-EA2-A3	OK Flux 10.72	OK Autrod 12.24
F8A6-EA2-A2	OK Flux 10.62	OK Autrod 12.24
F8A6-EA4-A4	OK Flux 10.62	OK Autrod 12.34
F8A6-EC-G	OK Flux 10.62	OK Tubrod 15.24S
F8A6-ENi2-Ni2	OK Flux 10.71	OK Autrod 13.27
F8A6-EC-G	OK Flux 10.71	OK Tubrod 15.24S
F8A8-ENi2-Ni2	OK Flux 10.72	OK Autrod 13.27
F8A10-ENi6-Ni6	OK Flux 10.62	OK Autrod 13.24
F8A15-ENi3-Ni3	OK Flux 10.62	OK Autrod 13.49
F9AZ-EC-B2	OK Flux 10.71	OK Tubrod 14.07S
F9AZ-EA2-A4	OK Flux 10.81	OK Autrod 12.24
F9A0-EA2-A3	OK Flux 10.70	OK Autrod 12.24
F9A0-EG-G	OK Flux 10.81	OK Autrod 13.36
F9A2-EA4-A3	OK Flux 10.74	OK Autrod 12.34
F9A8-EG-F3	OK Flux 10.62	OK Autrod 13.40
F11A8-EG-G	OK Flux 10.62	OK Autrod 13.43
F11A8-EC-G	OK Flux 10.62	OK Tubrod 15.27S
F8TA6-EA2TiB	OK Flux 10.71	OK Autrod 13.64
F8TA6-EA2TiB	OK Flux 10.74	OK Autrod 13.64
F8TA6-EA2TiB	OK Flux 10.77	OK Autrod 13.64
F8TA8-EA2TiB	OK Flux 10.72	OK Autrod 13.64

* Sorted by strength then toughness

Flux selection by classification

Classifications according to AWS (PWHT)

AWS PWHT (P)	Product / combination * Flux	Wire
not applicable	OK Flux 10.61	OK Autrod 12.10
F6PZ-EL12	OK Flux 10.83	OK Autrod 12.10
F6PZ-EL12	OK Flux 10.87	OK Autrod 12.10
F6PZ-EM12	OK Flux 10.87	OK Autrod 12.20
F6PZ-EM12K	OK Flux 10.87	OK Autrod 12.22
F6P0-EL12	OK Flux 10.80	OK Autrod 12.10
F6P0-EM12	OK Flux 10.80	OK Autrod 12.20
F6P0-EM12K	OK Flux 10.80	OK Autrod 12.22
F6P0-EM12K	OK Flux 10.88	OK Autrod 12.22
F6P4-EM12	OK Flux 10.71	OK Autrod 12.20
F6P4-EM12	OK Flux 10.77	OK Autrod 12.20
F6P5-EL12	OK Flux 10.71	OK Autrod 12.10
F6P5-EM12K	OK Flux 10.71	OK Autrod 12.22
F6P5-EM12K	OK Flux 10.77	OK Autrod 12.22
F6P6-EM12	OK Flux 10.74	OK Autrod 12.20
F6P6-EM12K	OK Flux 10.74	OK Autrod 12.22
F6P8-EM12K	OK Flux 10.61	OK Autrod 12.22
F6P8-EM12K	OK Flux 10.62	OK Autrod 12.22
F6P8-EM12	OK Flux 10.72	OK Autrod 12.20
F6P8-EM12K	OK Flux 10.72	OK Autrod 12.22
F7PZ-EL12	OK Flux 10.81	OK Autrod 12.10
F7PZ-EM12	OK Flux 10.81	OK Autrod 12.20
F7PZ-EM12K	OK Flux 10.81	OK Autrod 12.22
F7PZ-EM12K	OK Flux 10.83	OK Autrod 12.22
F7P0-EA2-A4	OK Flux 10.71	OK Autrod 12.24
F7P0-EA2-A4	OK Flux 10.74	OK Autrod 12.24
F7P2-EA2-A2	OK Flux 10.61	OK Autrod 12.24
F7P2-EM12	OK Flux 10.70	OK Autrod 12.20
F7P2-EA2-A2	OK Flux 10.77	OK Autrod 12.24
F7P4-EL12	OK Flux 10.70	OK Autrod 12.10
F7P4-EL12	OK Flux 10.76	OK Autrod 12.10
F7P5-EH12K	OK Flux 10.71	OK Autrod 12.32
F7P6-EH14	OK Flux 10.61	OK Autrod 12.40
F7P6-EH14	OK Flux 10.62	OK Autrod 12.40

AWS PWHT (P)	Product / combination * Flux	Wire
F7P6-ENi2-Ni2	OK Flux 10.71	OK Autrod 13.27
F7P8-EH12K	OK Flux 10.61	OK Autrod 12.32
F7P8-EC-G	OK Flux 10.61	OK Tubrod 15.24S
F7P8-EH12K	OK Flux 10.62	OK Autrod 12.32
F7P8-ENi1-Ni1	OK Flux 10.62	OK Autrod 13.21
F7P8-ENi2-Ni2	OK Flux 10.72	OK Autrod 13.27
F7P10-ENi2-Ni2	OK Flux 10.62	OK Autrod 13.27
F8P0-EB3R-B3	OK Flux 10.61	OK Autrod 13.20 SC
F8P2-EB2R-B2	OK Flux 10.61	OK Autrod 13.10 SC
F8P2-EB2R-B2	OK Flux 10.62	OK Autrod 13.10 SC
F8P2-EB3R-B3	OK Flux 10.62	OK Autrod 13.20 SC
F8P2-EB3R-B3R	OK Flux 10.63	OK Autrod 13.20 SC
F8P2-EA4-A3	OK Flux 10.71	OK Autrod 12.34
F8P2-EA4-A4	OK Flux 10.77	OK Autrod 12.34
F8P4-EB2R-B2R	OK Flux 10.63	OK Autrod 13.10 SC
F8P4-ENi6-Ni6	OK Flux 10.71	OK Autrod 13.24
F8P5-EA2-A3	OK Flux 10.72	OK Autrod 12.24
F8P6-EA2-A2	OK Flux 10.62	OK Autrod 12.24
F8P6-EA4-A4	OK Flux 10.62	OK Autrod 12.34
F8P8-ENi6-Ni6	OK Flux 10.62	OK Autrod 13.24
F8P15-ENi3-Ni3	OK Flux 10.62	OK Autrod 13.49
F9PZ-EA2-A3	OK Flux 10.70	OK Autrod 12.24
F9PZ-EA2-A4	OK Flux 10.81	OK Autrod 12.24
F9PZ-EB2R-G	OK Flux 10.81	OK Autrod 13.10 SC
F9P0-EA4-A3	OK Flux 10.74	OK Autrod 12.34
F9P8-EG-F3	OK Flux 10.62	OK Autrod 13.40
F10PZ-EB91-B91	OK Flux 10.64	OK Autrod 13.35
F11P8-EG-G	OK Flux 10.62	OK Autrod 13.43

* Sorted by strength then toughness

Flux selection by flux characteristics

Recommended applications; other use is possible.

Flux	Characteristics																	Page number									
	High Basic	Basic	Neutral basicity	Low basicity	Si alloying	Mn alloying	Ni alloying	Cr alloying	Neutral, see page 69	Active, see page 69	DC current	AC current	One sided	High speed	High Productivity	Rust and millscale	Pipemill welding		Low Impurity Level	High Dilution	Narrow Gap	H5 hydrogen class	good low-temperature toughness	With stainless wires	With Ni-base wires	Unlimited plate thickness	
Non and Low Alloyed Steel																											
OK Flux 10.61	•				L				•		•											•			•	18	
OK Flux 10.62	•								•		•	•									•	•	•			•	20
OK Flux 10.63	•								•		•	•						•			•	•				•	24
OK Flux 10.64	•								•	•	•											•				•	25
OK Flux 10.69		•											•														26
OK Flux 10.70		•			M	H				•	•	•								•							27
OK Flux 10.71		•			L	M			•		•	•	•	•			•				•	•				•	28
OK Flux 10.72		•				M			•		•	•			•							•	•			•	30
OK Flux 10.74		•			L	M			•		•	•		•			•					•				•	33
OK Flux 10.76		•			H	H				•	•	•									•						36
OK Flux 10.77		•			L	M			•		•	•		•			•					•				•	34
OK Flux 10.80			•		H	H				•	•	•									•						37
OK Flux 10.81				•	H	M				•	•	•		•			•										38
OK Flux 10.83				•	H					•	•	•		•													41
OK Flux 10.87				•	H					•	•	•		•													42
OK Flux 10.88				•	H	H				•	•	•				•	•										44
Stainless Steel and Nickel																											
OK Flux 10.16											•											•		•	•		46
OK Flux 10.90		•				•	•	•			•											•		•	•		48
OK Flux 10.92			•					•			•												•		•		50
OK Flux 10.93		•									•												•		•		52
OK Flux 10.94		•						•			•												•		•		54
OK Flux 10.95		•					•				•											•	•		•		55
OK Flux 10.99		•									•	•										•	•	•	•		56

- Valid
- H High
- M Medium
- L Low

Flux selection by wire type

Wire	EN ISO (wire)	AWS	OK Flux									
OK Autrod												
12.10	S1	EL12	10.61	10.70	10.71	10.76	10.80	10.81	10.83	10.87	10.88	
12.20	S2	EM12	10.70	10.71	10.72	10.74	10.77	10.80	10.81	10.87	10.88	
12.22	S2Si	EM12K	10.61	10.62	10.71	10.72	10.74	10.77	10.80	10.81	10.83	10.87
12.24	S2Mo; S S Mo	EA2	10.61	10.62	10.70	10.71	10.72	10.74	10.77	10.81		
12.30	S3		10.71	10.81								
12.32	S3Si	EH12K	10.61	10.62	10.71							
12.34	S3Mo; S S MnMo	EA4	10.62	10.71	10.74	10.77						
12.40	S4	EH14	10.61	10.62								
13.10 SC	S S CrMo1	EB2R	10.61	10.62	10.63	10.81						
13.20 SC	S S CrMo2	EB3R	10.61	10.62	10.63							
13.21	S2Ni1	ENi1	10.62									
13.24	S3Ni1Mo0,2	ENi6	10.62	10.71								
13.27	S2Ni2	ENi2	10.62	10.71	10.72							
13.33	S S CrMo5	EB6	Flux-wire combination on request									
13.35	S S CrMo91	EB91	10.64									
13.36	S2Ni1Cu	EG	10.61	10.71	10.81							
13.40	S3Ni1Mo	EG	10.62									
13.43	S3Ni2,5CrMo	EG	10.62									
13.49	S2Ni3	ENi3	10.62									
13.64	S2MoTiB	EA2TiB	10.71	10.72	10.74	10.77						
OK Tubrod												
14.00S			10.71									
14.07S			10.71									
15.00S			10.62	10.71								
15.24S			10.61	10.62	10.71							
15.25S			10.62									
15.27S			10.62									
OK Autrod												
308H	S 19 9 H	ER308H	10.93									
308L	S 19 9 L	ER308L	10.92	10.93	10.94	10.95	10.99					
309L	S 23 12 L	ER309L	10.92	10.93	10.99							
309MoL	S 23 12 L	(ER309MoL)	10.93									
310MoL	S 25 22 2 N L	(ER310MoL)	10.93									
310	S 25 20	ER310	10.90									
312	S 29 9	ER312	10.93									
316H	S 19 12 3 H	ER316H	10.93									
316L	S 19 12 3 L	ER316L	10.92	10.93	10.99							
317L	S 18 15 3 L	ER317L	10.93									
318	S 19 12 3 Nb	ER318	10.92	10.93								
347	S 19 9 Nb	ER347	10.92	10.93	10.94	10.95						
385	S 20 25 5 Cu L	ER385	10.93									
410NiMo	S 13 4		10.93									
2209	S 22 9 3 N L	ER2209	10.93									
2307	S 23 7 N L		10.93									
2509	S 25 9 4 N L	ER2594	10.93	10.94								
16.38	S 20 16 3 Mn L		10.93	10.99								
16.97	S 18 8 Mn	(ER307)	10.92	10.93								
NiCr-3	S Ni 6082 (NiCr20Mn3Nb)	ERNiCr-3	10.16	10.90								
NiCrMo-3	S Ni 6625 (NiCr22Mo9Nb)	ERNiCrMo-3	10.16	10.90								
NiCrMo-4	S Ni 6276 (NiCr15Mo16Fe6W4)	ERNiCrMo-4	10.90	10.99								
NiCrMo-13	S Ni 6059 (NiCr23Mo16)	ERNiCrMo-13	10.16	10.90								

Chemical composition of SAW wires

Wire	Classification	Typical chemical composition										Remark
		EN ISO	SFA/AWS	C	Si	Mn	P	S	Cr	Ni	Mo	
OK Autrod 12.10	EN ISO 14171-A: S1	A5.17: EL12	0.07	0.08	0.52	0.010	0.011	0.05	0.03	0.01		
OK Autrod 12.20	EN ISO 14171-A: S2	A5.17: EM12	0.10	0.07	1.06	0.013	0.013	0.06	0.03	0.01		
OK Autrod 12.22	EN ISO 14171-A: S2Si	A5.17: EM12K	0.09	0.19	1.01	0.011	0.013	0.04	0.03	0.01		
OK Autrod 12.24	EN ISO 14171-A: S2Mo EN ISO 24598-A: S S Mo	A5.23: EA2	0.09	0.14	1.08	0.012	0.010	0.05	0.02	0.48		
OK Autrod 12.30	EN ISO 14171-A: S3		0.11	0.13	1.61	0.013	0.015	0.06	0.02	0.01		
OK Autrod 12.32	EN ISO 14171-A: S3Si	A5.17: EH12K	0.13	0.30	1.77	0.013	0.007	0.05	0.02	0.01		
OK Autrod 12.34	EN ISO 14171-A: S3Mo EN ISO 24598-A: S S MnMo	A5.23: EA4	0.13	0.16	1.51	0.010	0.007	0.11	0.07	0.48		
OK Autrod 12.40	EN ISO 14171-A: S4	A5.17: EH14	0.12	0.08	2.04	0.013	0.009	0.09	0.06	0.01		
OK Autrod 13.10 SC	EN ISO 24598-A: S S CrMo1	A5.23: EB2R	0.10	0.12	0.83	0.006	0.006	1.21	0.03	0.49		X ≤ 11
OK Autrod 13.20 SC	EN ISO 24598-A: S S CrMo2	A5.23: EB3R	0.11	0.15	0.66	0.006	0.004	2.33	0.04	0.95		X ≤ 11
OK Autrod 13.21	EN ISO 14171-A: S2Ni1	A5.23: ENi1	0.11	0.15	0.98	0.008	0.007	0.09	0.90	0.01		
OK Autrod 13.24	EN ISO 14171-A: S3Ni1Mo0,2	A5.23: ENi6	0.12	0.23	1.52	0.011	0.009	0.06	0.88	0.19		
OK Autrod 13.27	EN ISO 14171-A: S2Ni2	A5.23: ENi2	0.10	0.14	1.02	0.008	0.006	0.04	2.19	0.01		
OK Autrod 13.33	EN ISO 24598-A: S S CrMo5	A5.23: EB6	0.09	0.42	0.51	0.007	0.006	5.73	0.07	0.53		
OK Autrod 13.35	EN ISO 24598-A: S S CrMo91	A5.23: EB91	0.10	0.22	0.52	0.004	0.003	8.82	0.67	0.92	Nb: 0.07 V: 0.20 N: 0.05	
OK Autrod 13.36	EN ISO 14171-A: S2Ni1Cu	A5.23: EG	0.10	0.29	0.95	0.012	0.012	0.29	0.78	0.02	Cu: 0.48	
OK Autrod 13.40	EN ISO 14171-A: S3Ni1Mo EN ISO 26304-A: S3Ni1Mo	A5.23: EG	0.11	0.16	1.63	0.011	0.006	0.09	0.86	0.51		
OK Autrod 13.43	EN ISO 26304-A: S3Ni2,5CrMo	A5.23: EG	0.12	0.19	1.55	0.014	0.011	0.67	2.29	0.47		
OK Autrod 13.49	EN ISO 14171-A: S2Ni3	A5.23: ENi3	0.09	0.15	0.95	0.004	0.003	0.02	3.28	0.01		
OK Autrod 13.64	EN ISO 14171-A: S2MoTiB	A5.23: EA2TiB	0.07	0.28	1.22	0.012	0.004	0.04	0.01	0.49	Ti: 0.14 B: 0.013	
OK Tubrod 14.00S			0.06	0.47	1.52	0.013	0.011	0.03	0.03	0.01		weld metal with 10.71
OK Tubrod 14.07S			0.07	0.45	1.05	0.015	0.010	1.18	0.03	0.51		weld metal with 10.71
OK Tubrod 15.00S			0.07	0.59	1.61	0.015	0.010	0.03	0.03	0.01		weld metal with 10.71
OK Tubrod 15.24S			0.08	0.24	1.61	0.013	0.007	0.03	0.65	0.13		weld metal with 10.62
OK Tubrod 15.25S			0.05	0.35	1.28	0.012	0.006	0.03	2.26	0.01		weld metal with 10.62
OK Tubrod 15.27S			0.07	0.40	1.90	0.011	0.006	0.08	2.44	0.32		weld metal with 10.62

Wire	Classification	Typical chemical composition												
		EN ISO	SFA/AWS	C	Si	Mn	P	S	Cr	Ni	Mo	N	FN	other
OK Autrod														
308H	EN ISO 14343-A: S 19 9 H	A5.9: ER308H	0.05	0.5	1.9	0.015	0.010	19.8	9.2	0.1	0.04			
308L	EN ISO 14343-A: S 19 9 L	A5.9: ER308L	0.02	0.4	1.9	0.015	0.010	19.8	9.8	0.1	0.05	11		
309L	EN ISO 14343-A: S 23 12 L	A5.9: ER309L	0.02	0.4	1.8	0.015	0.010	23.2	13.4	0.1	0.05	10		
309MoL	EN ISO 14343-A: S 23 12 2 L	A5.9: (ER309LMo)	0.01	0.4	1.5	0.020	0.010	21.4	14.6	2.5	0.05			
310	EN ISO 14343-A: S 25 20	A5.9: ER310	0.10	0.4	1.6	0.015	0.005	25.8	20.7	0.1	0.03			
310MoL	EN ISO 14343-A: S 25 22 2 N L	A5.9: (ER310MoL)	0.01	0.1	4.5	0.013	0.002	25.0	22.0	2.0	0.14			
312	EN ISO 14343-A: S 29 9	A5.9: ER312	0.10	0.4	1.6	0.020	0.005	30.7	8.8	0.1	0.03			
316H	EN ISO 14343-A: S 19 12 3 H	A5.9: ER316H	0.05	0.4	1.7	0.010	0.010	19.3	12.5	2.2	0.04			
316L	EN ISO 14343-A: S 19 12 3 L	A5.9: ER316L	0.01	0.4	1.7	0.015	0.010	18.2	12.0	2.6	0.04			
317L	EN ISO 14343-A: S 18 15 3 L	A5.9: ER317L	0.01	0.4	1.4	0.015	0.010	18.9	13.6	3.6	0.05	7		
318	EN ISO 14343-A: S 19 12 3 Nb	A5.9: ER318	0.04	0.4	1.8	0.015	0.010	18.9	11.5	2.6	0.04	11	Nb: 0.7	
347	EN ISO 14343-A: S 19 9 Nb	A5.9: ER347	0.04	0.4	1.4	0.015	0.010	19.2	9.5	0.1	0.05	7	Nb: 0.6	
385	EN ISO 14343-A: S 20 25 5 Cu L	A5.9: ER385	0.01	0.4	1.7	0.010	0.005	20.0	25.0	4.4	0.05		Cu: 1.5	
410NiMo	EN ISO 14343-A: S 13 4		0.02	0.4	0.5	0.020	0.010	12.4	4.2	0.6				
2209	EN ISO 14343-A: S 22 9 3 N L	A5.9: ER2209	0.01	0.5	1.5	0.015	0.002	22.7	8.5	3.2	0.17			
2307	EN ISO 14343-A: S 23 7 N L		0.01	0.5	1.4	0.020	0.010	23.2	7.1	0.4	0.15		Cu: 0.2	
2509	EN ISO 14343-A: S 25 9 4 N L	A5.9: ER2594	0.01	0.4	0.4	0.015	0.010	25.2	9.4	3.9	0.24			
16.38	EN ISO 14343-A: S 20 16 3 Mn L		0.01	0.4	6.9	0.015	0.010	19.9	16.5	3.0	0.18			
16.97	EN ISO 14343-A: S 18 8 Mn	A5.9: (ER307)	0.07	0.4	6.5	0.013	0.010	18.9	8.2	0.1				
NiCr-3	EN ISO 18274: S Ni 6082 (NiCr20Mn3Nb)	A5.14: ERNiCr-3	0.04	0.2	3.0	0.005	0.003	20.0	Bal.	0.1			Nb: 2.5, Fe: 1.3	
NiCrMo-3	EN ISO 18274: S Ni 6625 (NiCr22Mo9Nb)	A5.14: ERNiCrMo-3	0.02	0.05		0.007	0.003	22.7	Bal.	8.6			Nb: 3.5, Fe: 0.3	
NiCrMo-4	EN ISO 18274: S Ni 6276 (NiCr15Mo16Fe6W4)	A5.14: ERNiCrMo-4	0.01	0.05	0.45	0.005	0.003	15.5	Bal.	16.1			W: 3.5, Co: 0.1, Fe: 5.8	
NiCrMo-13	EN ISO 18274: S Ni 6059 (NiCr23Mo16)	A5.14: ERNiCrMo-13	0.01	0.1	0.2	0.010	0.003	23.0	Bal.	16.0			Al: 0.3, Fe: 1.0	

How to choose the right flux-wire combination

Stainless steel

When joining stainless steel the wire shall be of the same chemical composition as the base material or over-alloyed. For similar wires a low-C variant should be chosen over a Nb-stabilized as long as it is permitted by the customer contract.

OK Flux 10.93 is often the correct flux, but alternative fluxes are chosen if the ferrite content needs to be changed slightly or if the risk of hot cracking needs to be reduced.

Ni-alloys and 9% Ni-steels

Ni-alloys are welded with OK Flux 10.90. The wire shall be of the same chemical composition as the base material.

9% Ni-steels are also welded with OK Flux 10.90 or OK Flux 10.99 and various welding wires e.g.

OK Autrod NiCrMo-3, NiCrMo-4 and NiCrMo-13.

Non and low alloyed steels

Fluxes can be chosen for particular applications, such as low impurity levels in creep resistant steels, pipemills, welding on rust or mill scale, narrow gap welding or low temperature toughness. The correct flux for these applications can be chosen with the flux characteristics selection chart on page 13. For some low alloyed steels, e.g. creep resistant steels, the chemistry of the filler wire shall match the chemistry of the base material. The corresponding fluxes are selected with the table on page 14. For other applications, the best flux-wire-combination is identified by criteria such as running characteristics, specified toughness and strength or joint preparation.

Flux basicity

Basicity is calculated from a flux's chemical components, independently of the wire. Higher basicity gives better impact values, but reduces features such as welding speed, parameter envelope or fine rippling of the weld bead. It is therefore beneficial to choose the lowest possible flux basicity at the specified toughness. From the various basicity formulas the following is the most generally accepted one:

$$B = \frac{\text{CaO} + \text{MgO} + \text{Na}_2\text{O} + \text{K}_2\text{O} + \text{CaF}_2 + \frac{1}{2}(\text{MnO} + \text{FeO})}{\text{SiO}_2 + \frac{1}{2}(\text{Al}_2\text{O}_3 + \text{TiO}_2 + \text{ZrO}_2)}$$

Based on this formula fluxes are divided into the following groups:

B < 0.9	low basicity flux
B = 0.9 – 1.2	neutral basicity flux
B > 1.2 – 2.0	basic flux
B > 2.0	high basic flux

The formula shows that low basicity fluxes contain more multiple oxides. A certain amount of atomically bonded oxygen is favourable for the weld microstructure. In all weld metal, however, this favourable level is already exceeded, even with high basic fluxes. Typical oxygen levels are:

Low basicity flux	> 750 ppm
Neutral basicity flux	550 – 750 ppm
Basic flux	300 – 550 ppm
High basic flux	< 300 ppm

In highly diluted welds with low oxygen parent material, however, the oxygen level can fall below the favourable level. The different basicity and oxygen levels lead to large differences in all weld metal toughness with the same wire, Autrod 12.22:

Low basicity flux	OK Flux 10.81	>47J/ +20°C
Basic flux	OK Flux 10.71	>47J/ -40°C
High basic flux	OK Flux 10.62	>47J/ -50°C

Strength

The strength of non-alloyed weld metal is mainly achieved with C, Mn and Si. A number of wires are available for various strength levels, using the same flux. Generally, the weld strength should match the base metal. The flux also influences the strength level, because each flux alloys different amounts of Mn and Si to the weld metal.

Welding joint

Dilution also affects the Mn and Si content, making mechanical properties of actual joints differ largely from all weld metal. A multi-run V-joint consists of approximately 90% weld metal with mechanical properties similar to all weld metal. In a square butt joint, however, only 20% is weld metal resulting in mechanical properties that are largely influenced by the parent material chemistry (see page 59 - 61).

Approvals

Approval society requirements are taken into account when specifying a flux/wire combination. Alternative combinations may be used, if the preferred one does not have the required approval (e.g.: CE-marking, marine societies, federal approvals, TÜV, DB). Please contact ESAB, if no combination fulfils the customer approval requirements.

Product data pages



OK Flux 10.61 – High basic flux for DC welding

OK Flux 10.61 is an agglomerated, high-basic flux for submerged arc welding. It is used for single and multi-run butt welding when demands on impact toughness values are high. This is a good alternative to other high basic fluxes when welding is done with single wire DC+.

The flux alloys very little Si and Mn to the weld metal and thus it is well suited for welding of unlimited plate thicknesses.

OK Flux 10.61 is used in general construction, pressure vessel construction, power generation and transport industries.

Classification flux	Basicity index	Density	Grain size
EN ISO 14174: S A FB 1 65 DC	2.6	~ 1.1 kg/dm ³	0.2 - 1.6 mm

Slag type	Polarity	Alloy transfer
Fluoride-basic	DC+	Slightly Si and no Mn alloying

Flux consumption kg flux / kg wire

Voltage	DC+
26	0.7
30	1.0
34	1.3
38	1.6

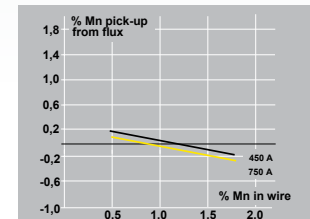
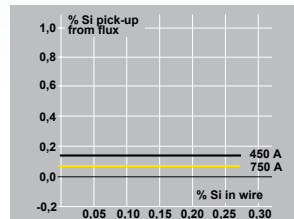

Single wire, ø 4.0 mm, DC+, 30 V, 60 cm/min

Classification

	Wire	Weld metal		
OK Autrod	EN / AWS	EN / AW	AWS / AW	AWS / PWHT
12.10	S1 / EL12	S 35 2 FB S1		
12.22	S2Si / EM12K	S 38 4 FB S2Si	A5.17: F7A8-EM12K	A5.17: F6P8-EM12K
12.24	S2Mo; S S Mo / EA2	S 42 2 FB S2Mo	A5.23: F7A4-EA2-A2	A5.23: F7P2-EA2-A2
12.32	S3Si / EH12K	S 42 5 FB S3Si	A5.17: F7A6-EH12K	A5.17: F7P8-EH12K
12.40	S4 / EH14	S 46 3 FB S4	A5.17: F7A6-EH14	A5.17: F7P6-EH14
13.10 SC	S S CrMo1 / EB2R	S S CrMo1 FB (PWHT)		A5.23: F8P2-EB2R-B2
13.20 SC	S S CrMo2 / EB3R			A5.23: F8P0-EB3R-B3
13.36	S2Ni1Cu / EG	S 46 3 FB S2Ni1Cu		
OK Tubrod				
15.24S				A5.23: F7P8-EC-G

Approvals

	ABS	BV	DNV-GL	LR	TÜV	DB	CE
OK Flux 10.61						x	x
with OK Autrod							
12.10					x	x	x
12.22							x
12.24					x		x
12.32							x
13.10 SC					x	x	x
13.20 SC					x		
13.36						x	x

Typical weld metal chemical composition (%), DC+

	C	Si	Mn	Cr	Ni	Mo	Other
With OK Autrod							
12.10	0.07	0.1	0.5				
12.22	0.08	0.3	1.0				
12.24	0.06	0.2	1.0			0.5	
12.32	0.09	0.3	1.4				
12.40	0.08	0.2	1.8				
13.10 SC	0.08	0.3	0.7	1.1		0.5	
13.20 SC	0.08	0.3	0.8	2.1		1.0	
13.36	0.07	0.5	1.0	0.2	0.7		Cu: 0.4
with OK Tubrod							
15.24S	0.05	0.4	1.6		0.8		

Typical weld metal mechanical properties, DC+

	ReL / Rp0.2 (MPa)	Rm (MPa)	A4 / A5 (%)	CVN (J at °C)		AW/ SR	Remarks	
With OK Autrod				0	-20	-40	-62	
12.10	365	445	30	140	100		AW	
12.22	440	520	30		120	75	35	AW
12.24	480	570	26	120	80	35		AW
12.32	450	560	27		120	100	35	AW CVN at -50°C: 55 J
12.40	490	580	26		80	40		AW CVN at -51°C: 35 J
13.36	545	640	25		70	40		AW CVN at -30°C: 55 J
With OK Tubrod								
15.24S	490	590	29			90		AW
With OK Autrod								
12.22	410	500	30		110	80	35	SR
12.24	440	530	26	70	45			SR CVN at -29°C: 40 J
12.32	420	530	27		180	150	80	SR
12.40	440	530	26		85	45		SR CVN at -51°C: 40 J
13.10 SC	550	620	26					SR CVN at -29°C: 70 J
13.10 SC	290	400						SR SR: 720°C / 15 h Test temp.: 400 °C
13.10 SC	280	390						SR SR: 720°C / 15 h Test temp.: 500 °C
13.20 SC	540	630	25					SR CVN at -18°C: 80 J
13.20 SC	430	530	17					SR SR: 680°C / 1 h Test temp.: 400 °C
13.20 SC	360	450	21					SR SR: 680°C / 1 h Test temp.: 500 °C

For more information view the Product Data Sheets or contact ESAB.

OK Flux 10.62 – High impact flux for critical applications

OK Flux 10.62 is an agglomerated, high-basic flux for submerged arc welding. It is used for multi-run welding of thick section materials. When high demands on impact toughness values are required, OK Flux 10.62 is the flux to use. The flux is neutral on Si and Mn alloying.

It can be used for single and multi-wire procedures, for butt and fillet welds and works equally well on DC and AC current. Since no alloying takes place, it is perfect for multi-layer welding of unlimited plate thickness. OK Flux 10.62 is especially suited for narrow gap welding due to good slag detachability and smooth sidewall blending. It operates optimally at the lower end of the voltage range. The weld metal produced has a low-oxygen content; approx. 300ppm and hydrogen levels lower than 5ml/100g.

When delivered in BlockPac™ packaging (moisture protected) it is ensured that weld metal hydrogen levels are not more than 4ml/100g without re-drying prior to use.

Continues next page

Classification flux	Basicity index	Density	Grain size
EN ISO 14174: S A FB 1 55 AC H5	3.2	~ 1.1 kg/dm ³	0.2 - 1.6 mm
EN ISO 14174: S A FB 1 55 AC H4 (only BlockPac/moisture protection)			

Slag type	Polarity	Alloy transfer	Hydrogen
Fluoride-basic	DC+ / AC	No Si or Mn alloying	≤ 5 HDM
			≤ 4 HDM (BlockPac)

Flux consumption kg flux / kg wire

Voltage	DC+	AC
26	0.7	0.6
30	1.0	0.9
34	1.3	1.2
38	1.6	1.4

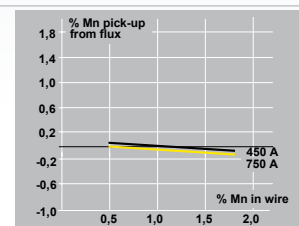
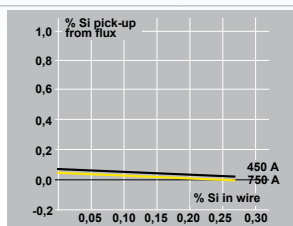

Single wire, ø 4.0 mm, DC+, 30 V, 60 cm/min

Classification

Wire	Weld metal			
OK Autrod	EN / AWS	EN / AW	AWS / AW	AWS / PWHT
12.22	S2Si / EM12K	S 38 5 FB S2Si	A5.17: F7A8-EM12K	A5.17: F6P8-EM12K
12.24	S2Mo; S S Mo / EA2	S 46 4 FB S2Mo	A5.23: F8A6-EA2-A2	A5.23: F8P6-EA2-A2
12.32	S3Si / EH12K	S 46 6 FB S3Si	A5.17: F7A8-EH12K	A5.17: F7P8-EH12K
12.34	S3Mo; S S MnMo / EA4	S 50 4 FB S3Mo	A5.23: F8A6-EA4-A4	A5.23: F8P6-EA4-A4
12.40	S4 / EH14	S 50 4 FB S4	A5.17: F7A6-EH14	A5.17: F7P6-EH14
13.10 SC	S S CrMo1 / EB2R	S S CrMo1 FB (PWHT)		A5.23: F8P2-EB2R-B2
13.20 SC	S S CrMo2 / EB3R	S S CrMo2 FB (PWHT)		A5.23: F8P2-EB3R-B3
13.21	S2Ni1 / ENi1	S 42 4 FB S2Ni1	A5.23: F7A6-ENi1-Ni1	A5.23: F7P8-ENi1-Ni1
13.24	S3Ni1Mo0,2 / ENi6	S 50 6 FB S3Ni1Mo0,2	A5.23: F8A10-ENi6-Ni6	A5.23: F8P8-ENi6-Ni6
13.27	S2Ni2 / ENi2	S 46 7 FB S2Ni2	A5.23: F7A10-ENi2-Ni2	A5.23: F7P10-ENi2-Ni2
13.40	S3Ni1Mo / EG	S 55 6 FB S3Ni1Mo	A5.23: F9A8-EG-F3	A5.23: F9P8-EG-F3
13.43	S3Ni2,5CrMo / EG	S 69 6 FB S3Ni2,5CrMo	A5.23: F11A8-EG-G	A5.23: F11P8-EG-G
13.49	S2Ni3 / ENi3	S 46 8 FB S2Ni3	A5.23: F8A15-ENi3-Ni3	A5.23: F8P15-ENi3-Ni3
OK Tubrod				
15.24S			A5.23: F8A6-EC-G	
15.25S			A5.23: F7A8-EC-Ni2	
15.27S			A5.23: F11A8-EC-G	

Approvals *

	ABS	BV	DNV-GL	LR	TÜV	DB	CE
OK Flux 10.62						x	x
with OK Autrod							
12.22	3YM	3YM	III YM	3YM	x	x	x
12.24					x		x
12.32	4YQ420M	4Y42M	IV Y42M V Y46M**	4Y42M	x	x	x
12.34	4YQ500M	4Y50M	IV Y50M	4Y50M			
13.10 SC					x	x	x
13.20 SC					x		x
13.24			V Y46M**				x
13.27	5YQ460M	5Y46M	V Y46M	5Y46M	x	(x)	x
13.40	4YQ550M	4Y55M	IV Y55M	4Y55M	x		x
13.43	4YQ690M	4Y69M	IV Y69M	4Y69M			x
with OK Tubrod							
15.24S							x
15.25S					x		
15.27S	5YQ690M		V Y69M	5Y69M			

* For a full approval listing, view the Product Data Sheet or contact ESAB

** Selected production units only

Typical weld metal chemical composition (%), DC+

	C	Si	Mn	Cr	Ni	Mo	Other
With OK Autrod							
12.22	0.07	0.3	1.0				
12.24	0.07	0.2	1.0			0.5	
12.32	0.10	0.3	1.6				
12.34	0.10	0.2	1.4			0.5	
12.40	0.08	0.1	1.9				
13.10 SC	0.08	0.2	0.7	1.1		0.5	
13.20 SC	0.08	0.2	0.6	2.2		0.9	
13.21	0.06	0.2	1.0		0.9		
13.24	0.08	0.3	1.4		0.9	0.2	
13.27	0.06	0.2	1.0		2.1		
13.40	0.07	0.3	1.5		0.9	0.5	
13.43	0.11	0.2	1.5	0.6	2.2	0.5	
13.49	0.06	0.2	1.0		3.1		
With OK Tubrod							
15.00S	0.05	0.4	1.4				
15.24S	0.06	0.3	1.6		0.8		
15.25S	0.05	0.4	1.3		2.3		
15.27S	0.07	0.4	1.9		2.4	0.3	

Typical weld metal mechanical properties, DC+

	ReL / Rp0.2 (MPa)	Rm (MPa)	A4 / A5 (%)	CVN (J at °C)			AW/ SR	Remarks
With OK Autrod				-40	-50	-60	-73	
12.22	410	500	33	90	70	40	AW	
12.24	500	580	25	60	45		AW	
12.32	475	560	28	110		75	AW	
12.34	540	620	24	115	45		AW	
12.40	530	620	26	50	40		AW	
13.21	470	560	28	70	60		AW	
13.24	530	620	25	120	110	70	50	AW
13.27	460	570	28	110		80	50	AW
13.40	610	690	24	90	80			AW
13.43	700	800	21	75	65	55		AW
13.49	500	600	27				85	AW
With OK Tubrod								
15.00S	430	510	31	130				AW
15.24S	540	630	29	150	130			AW
15.25S	490	580	29			100		AW
15.27S	750	845	22			80		AW
With OK Autrod								
12.22	360	480	34	130	75	40		SR
12.24	510	580	30	55	40			SR
12.32	410	510	28	110		65		SR
12.34	540	620	25	70	40			SR
12.40	460	560	26	45	35			SR
13.10 SC	500	610	26					SR
13.10 SC	420	530						SR
13.10 SC	300	430						SR
13.20 SC	525	620	25					SR
13.20 SC	455	575	20					SR
13.20 SC	435	545	21					SR
13.21	435	540	30	110	70	65		SR
13.24	500	590	27	120	100	70		SR
13.27	460	570	28	100		90	40	SR
13.40	600	680	26	60				SR
13.43	695	790	21	60	50			SR
13.49	510	570	29				85	SR

For more information view the Product Data Sheets or contact ESAB.

OK Flux 10.62 is used when high demands on low-temperature toughness, strength and CTOD-values are required. Many offshore constructions, drilling rigs, platforms, etc. are welded with OK Flux 10.62. It is used for all types of pressure vessels including those for nuclear applications. In power generation it can be welded with applicable wires on creep resistant steels.

Other applications include shipbuilding steels up to EH69 with various wires and approvals. It is also used on multi-run welded pipes, e.g. for special applications at low temperatures, or on high strength steels, structural steels, and fine-grained steels, including in civil construction and transport industries.

OK Flux 10.62 has passed CTOD tests with the following wires:

OK Autrod 12.32 at -10°C and -15°C,
 OK Autrod 13.24 at -10°C and -15°C,
 OK Autrod 13.27 at -10°C,
 OK Autrod 13.40 at -10°C,
 OK Tubrod 15.24S at -10°C,
 OK Tubrod 15.25S at -10°C.



Narrow gap welding - complete ESAB solution for repetitive fabrication of thick sections

Narrow gap welding becomes attractive with heavy wall thickness sections in repetitive fabrication, e.g. the fabrication of foundation piles for the offshore and wind energy segments. ESAB provides a total solution which includes specialised welding equipment, welding consumables and automation.

The main advantage of narrow gap welding is the greatly reduced weld volume in very thick sections, which results in weld cycle time reduction. Furthermore, the one-sided butt arrangement makes it easier to avoid linear misalignments, as opposed to two-sided joints (X prep.).

When considering this process, it must be taken into account that it involves a large initial investment, as well as the more expensive machining of narrow gap joint preparations. These need to be fully justified by cost analysis, in which ESAB can assist.

It is essential that the process operates free from inconsistencies. The side-wall wetting must be perfect in order to avoid lack of fusion in the following layer. Slag is required to be self releasing, even on preheated high strength steels.

OK Flux 10.62 meets all these criteria, and is also very suited when low hydrogen is required to avoid cold cracking. It is an EN ISO 14174 H5 classified flux which is suited for low-temperature steels, due to its high basicity. Delivered in BlockPac - moisture protection - OK Flux 10.62 also performs to H4 hydrogen class.

Narrow gap welding can be single or tandem wire; both requiring specially designed welding heads (swords), narrow enough to fit into the joint preparation. All heads - including types with contact jaws, flux supply, flux recovery or tactile sensors - are insulated. This is to avoid unwanted arcing, when the equipment accidentally moves against the joint edges. Typical wire diameters are 3 and 4 mm. Up to 350 mm thickness can be welded with the standard ESAB head, but special versions are available for thicker sections.

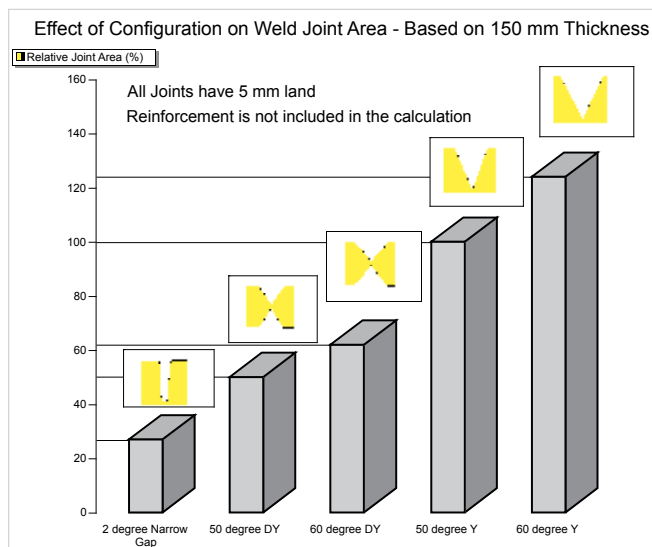
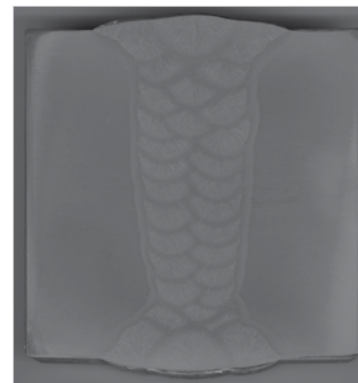

In 150 mm material thickness, 5 mm land - reinforcement not included.

OK Flux 10.63 – High impact flux especially for creep resistant steels

OK Flux 10.63 is an agglomerated, high-basic flux for submerged arc welding. It is used for multi-run welding of creep resistant Cr-Mo-alloyed steels when high toughness values are required, even after step cooling heat treatment.

It can be used for single and multi-wire procedures, for butt and fillet welds and works equally well on DC and AC current. The flux is neutral in terms of Si and Mn alloying and thus it is perfect for multi-layer welding of unlimited plate thicknesses. It is well suited for narrow gap welding, due to good slag detachability and smooth sidewall blending. The optimum voltage is at the lower end of the voltage range. The weld metal produced has a very low level of impurities with a maximum X-factor value of 15 with various wires. It has a low oxygen content, approx. 300ppm and hydrogen levels lower than 5ml/100g.

OK Flux 10.63 is used in the petrochemical, chemical, power generation and pressure vessels industries, mainly for creep resistant steels when the requirements on toughness values are high. Due to the very clean weld metal, it is especially suited when stringent requirements after a step cooling treatment need to be fulfilled.

Classification flux	Basicity index	Density	Grain size
EN ISO 14174: S A FB 1 55 AC H5	3.0	~ 1.1 kg/dm ³	0.2 - 1.6 mm

Slag type	Polarity	Alloy transfer	Hydrogen
Fluoride-basic	DC+ / AC	No Si or Mn alloying	≤ 5 HDM

Flux consumption kg flux / kg wire

Voltage	DC+	AC
26	0.7	0.6
30	1.0	0.9
34	1.3	1.2
38	1.6	1.4

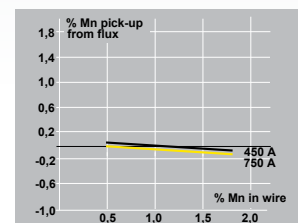
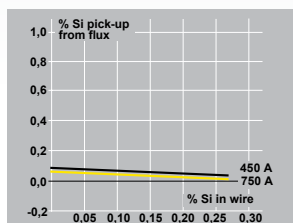

Single wire, ø 4.0 mm, DC+, 30 V, 60 cm/min

Classification

	Wire	Weld metal	
OK Autrod	EN / AWS	EN / PWHT	AWS / PWHT
13.10 SC	S S CrMo1 / EB2R	S S CrMo1 FB	A5.23: F8P4-EB2R-B2R
13.20 SC	S S CrMo2 / EB3R	S S CrMo2 FB	A5.23: F8P2-EB3R-B3R

Typical weld metal chemical composition (%), DC+

	C	Si	Mn	Cr	Ni	Mo	Other	Remarks
With OK Autrod								
13.10 SC	0.08	0.2	0.8	1.2		0.5	P ≤ 0.010	X ≤ 15*
13.20 SC	0.07	0.2	0.6	2.1		1.0	P ≤ 0.010	X ≤ 15*

$$* X = \frac{(10P + 5Sb + 4Sn + As)}{100} \text{ elements in ppm}$$

Typical weld metal mechanical properties, DC+

	ReL / Rp0.2 (MPa)	Rm (MPa)	A4 / A5 (%)	CVN (J at °C)	AW/SR	Remarks
With OK Autrod				-20 -29 -40		
13.10 SC	500	600	25	110	80	SR: 690°C / 1 h
13.10 SC	490	580	27	100	70	SR: 690°C / 3 h
13.20 SC	520	610	25	100	80	SR: 690°C / 4 h

For more information view the Product Data Sheets or contact ESAB.



OK Flux 10.64 – High basic flux for T/P91 steels

Classification flux	Basicity index	Density	Grain size
EN ISO 14174: S A FB 1 54 DC H5	2.6	~ 1.1 kg/dm ³	0.2 - 1.6 mm

Slag type	Polarity	Alloy transfer	Hydrogen
Fluoride-basic	DC+	No Si alloying, Mn slightly reducing	<5 HDM

Flux consumption kg flux / kg wire

Voltage	DC+
26	0.7
30	1.0
34	1.3
38	1.6

Classification

	Wire	Weld metal		
OK Autrod	EN / AWS	EN / AW	AWS / AW	AWS / PWHT
13.35	S S CrMo91 / EB91			A5.23: F10PZ-EB91-B91

Typical weld metal chemical composition (%), DC+

	C	Si	Mn	Cr	Ni	Mo	V	Nb	N	Other	Remarks
With OK Autrod											
13.35	0.11	0.3	0.5	9.0	0.7	0.9	0.18	0.06	0.05	P ≤ 0.010	Mn+Ni ≤ 1.40

Typical weld metal mechanical properties, DC+

	ReL / Rp0.2 (MPa)	Rm (MPa)	A4 / A5 (%)	AW/ SR	Remarks
With OK Autrod					
13.35	670	780	20	SR	SR: 760°C / 2 h

For more information view the Product Data Sheets or contact ESAB.



Picture: Al Shabia Eng. HFZE-UAE

An agglomerated, high basic flux for Submerged Arc Welding especially designed for joining T/P91 steels. With the wire OK Autrod 13.35 the weld metal fully complies with the B91 weld metal classification according to SFA/AWS A5.23.

The flux can be used for single layer or multi-layer procedures of unlimited plate thickness. It compensates for C and Cr burn-out to ensure both the wire and weld metal chemistries fully conform to the AWS requirements. OK Flux 10.64 has a very good slag detachability. It produces a weld metal with hydrogen levels below 5ml/100g and is welded using DC+ polarity only.

OK Flux 10.64 is used in the thermal power generation industry as well as for pressure vessels. The flux-wire combination also meets the additional customer requirement of the Mn+Ni level being not more than 1.40%.

OK Flux 10.69 – Backing flux for one-sided welding

An agglomerated, basic flux specifically designed as a backing flux for one-sided submerged arc welding.

The flux creates a perfect root weld with a smooth surface and has a good capability to support the molten weld pool, even at high heat inputs. Since this flux is a backing flux it does not take part in the welding process in a metallurgical way, so no alloying takes place from this flux.

OK Flux 10.69 is mainly used in shipbuilding industries where it is applied to a copper backing bar with a groove that supports the flux on the backside of the weld joint. Welding is done with single wire, tandem or 3-wire-systems. Plates up to approx 25mm thickness can be welded in one run from a single side.

Classification flux	Basicity index	Density	Grain size
EN ISO 14174: S A CS 4	1.8	~ 1.3 kg/dm ³	0.2 - 1.25 mm

Slag type	Polarity	Alloy transfer
Calcium-silicate	Not applicable	No alloying

For more information view the Product Data Sheets or contact ESAB.



OK Flux 10.70 – For high dilution applications

Classification flux	Basicity index	Density	Grain size
EN ISO 14174: S A AB 1 79 AC	1.4	~ 1.2 kg/dm ³	0.2 - 1.6 mm

Slag type	Polarity	Alloy transfer
Aluminate-basic	DC+ / AC	Moderately Si and very high Mn alloying

Flux consumption kg flux / kg wire

Voltage	DC+	AC
26	0.7	0.6
30	1.0	0.9
34	1.3	1.2
38	1.6	1.4

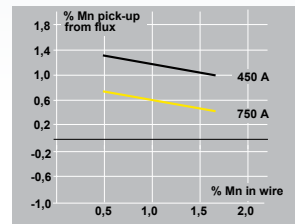
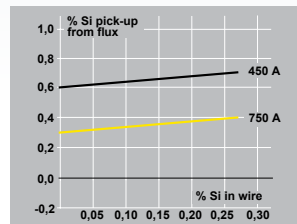

Single wire, ø 4.0 mm, DC+, 30 V, 60 cm/min

Classification

	Wire	Weld metal		
OK Autrod	EN / AWS	EN / AW	AWS / AW	AWS / PWHT
12.10	S1 / EL12	S 42 3 AB S1	A5.17: F7A4-EL12	A5.17: F7P4-EL12
12.20	S2 / EM12	S 46 3 AB S2	A5.17: F7A2-EM12	A5.17: F7P2-EM12
12.24	S2Mo; S S Mo / EA2	S 50 0 AB S2Mo	A5.23: F9A0-EA2-A3	A5.23: F9PZ-EA2-A3

Approvals*

	ABS	BV	DNV-GL	LR	TÜV	DB	CE
OK Flux 10.70						x	x
with OK Autrod							
12.10	3YM	3YM	III YM	3YM	x	x	x
12.20					x	x	x

*For a full approval listing, view the Product Data Sheet or contact ESAB

Typical weld metal chemical composition (%), DC+

	C	Si	Mn	Cr	Ni	Mo	Other
With OK Autrod							
12.10	0.05	0.5	1.7				
12.20	0.06	0.6	1.9				
12.24	0.06	0.6	2.0			0.5	

Typical weld metal mechanical properties, DC+

	ReL / Rp0.2 (MPa)	Rm (MPa)	A4 / A5 (%)	CVN (J at °C)		AW/ SR	Remarks
With OK Autrod							
12.10	430	520	30	100	-18	-30	-40
12.20	470	580	29	90	80	55	40
12.24	580	670	23	50	40		
12.10	410	510	30	90	70		35
12.20	430	550	28	80	65	40	
12.24	560	660	24	40			

For more information view the Product Data Sheets or contact ESAB.

OK Flux 10.70 is an agglomerated, basic flux for submerged arc welding. It is designed for welding joints with high dilution such as I-joints with one run from each side and fillet welds. Due to its high alloying of mainly Mn, it creates a weld metal with good toughness values in these joints.

It can be used for single and multi-wire procedures and works equally well on DC and AC. On multi-pass welding the number of passes is limited and the plate thickness should not exceed approx. 25mm. Non-alloyed wires such as OK Autrod 12.10 and OK Autrod 12.20 are the preferred ones to be used in combination with OK Flux 10.70.

The main application area for OK Flux 10.70 is in shipbuilding. Here it is used preferably in the two run, double-sided technique. However, it is also used in other market segments where joints with high dilution or a limited number of passes are welded. This is in the construction of pressure vessels, in the transport industries and general construction.

OK Flux 10.71 – General application flux with excellent welding performance

OK Flux 10.71 is an agglomerated, basic flux for submerged arc welding. It is used for single and multi-run welding of all plate thicknesses. It can be combined with a wide range of solid wires and cored wires and thus it is suitable for all steel types. OK Flux 10.71 combines good sub zero toughness levels with excellent weldability.

It is used for single and multi-wire procedures such as tandem, twin-arc, tandem-twin welding and many more, for butt, overlap and fillet welds. It works equally well on DC and AC current. The good slag detachability and limited alloying of Si and Mn makes it well suited for multi-pass thick section welding. High welding speeds can be achieved producing a finely rippled weld metal, all this in combination with very good impact values.

In general construction, OK Flux 10.71 is one of the most commonly used SAW fluxes. Not just for structural steels and fine-grained steels, but also for weather resistant steels e.g. for bridges. Pressure

Continues next page

Classification flux	Basicity index	Density	Grain size
EN ISO 14174: S A AB 1 67 AC H5	1.5	~ 1.2 kg/dm ³	0.2 - 1.6 mm, 0.315 - 2.0 mm

Slag type	Polarity	Alloy transfer	Hydrogen
Aluminate-basic	DC+ / AC	Slightly Si and moderately Mn alloying	≤ 5 HDM

Flux consumption kg flux / kg wire

Voltage	DC+	AC
26	0.7	0.6
30	1.0	0.9
34	1.3	1.2
38	1.6	1.4

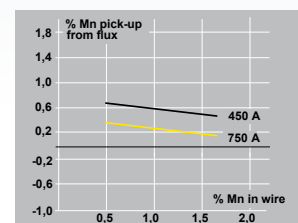
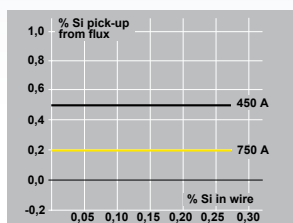

Single wire, ø 4.0 mm, DC+, 30 V, 60 cm/min

Classification

	Wire	Weld metal		
OK Autrod	EN / AWS	EN / AW	AWS / AW	AWS / PWHT
12.10	S1 / EL12	S 35 4 AB S1	A5.17: F6A4-EL12	A5.17: F6P5-EL12
12.20	S2 / EM12	S 38 4 AB S2	A5.17: F7A4-EM12	A5.17: F6P4-EM12
12.22	S2Si / EM12K	S 38 4 AB S2Si	A5.17: F7A5-EM12K	A5.17: F6P5-EM12K
12.24	S2Mo; S S Mo / EA2	S 46 2 AB S2Mo	A5.23: F8A2-EA2-A4	A5.23: F7P0-EA2-A4
12.30	S3	S 46 3 AB S3		
12.32	S3Si / EH12K	S 46 4 AB S3Si	A5.17: F7A5-EH12K	A5.17: F7P5-EH12K
12.34	S3Mo; S S MnMo / EA4	S 50 3 AB S3Mo	A5.23: F8A4-EA4-A3	A5.23: F8P2-EA4-A3
13.24	S3Ni1Mo0,2 / ENi6	S 50 4 AB S3Ni1Mo0,2	A5.23: F8A5-ENi6-Ni6	A5.23: F8P4-ENi6-Ni6
13.27	S2Ni2 / ENi2	S 46 5 AB S2Ni2	A5.23: F8A6-ENi2-Ni2	A5.23: F7P6-ENi2-Ni2
13.36	S2Ni1Cu / EG	S 46 3 AB S2Ni1Cu	A5.23: F8A2-EG-G	
13.64	S2MoTiB / EA2TiB		A5.23: F8TA6-EA2TiB	
OK Tubrod				
14.00S		S 42 2 AB T3	A5.17: F7A2-EC1	
14.07S			A5.23: F9AZ-EC-B2	
15.00S		S 42 4 AB T3	A5.17: F7A4-EC1	
15.24S			A5.23: F8A6-EC-G	

Approvals*

	ABS	BV	DNV-GL	LR	TÜV	DB	CE
OK Flux 10.71						x	x
with OK Autrod							
12.10	3M	3M	III M	3M	x	x	x
12.20	3YM	3YM	III YM	3YM	x	x	x
12.22	4Y400M	4Y40M	IV Y40M	4Y40M	x	x	x
12.24	3YTM	3YTM	III YTM	3YTM	x	x	x
12.30					x	x	x
12.32					x	x	x
13.27					x		
13.36							x
with OK Tubrod							
14.00S	3YM	3YM	III YM	3YM	x	x	x
15.00S	3YM		III YM	3YM	x	x	x

*For a full approval listing, view the Product Data Sheet or contact ESAB

Typical weld metal chemical composition (%), DC+

	C	Si	Mn	Cr	Ni	Mo	Other
With OK Autrod							
12.10	0.04	0.3	1.0				
12.20	0.05	0.3	1.4				
12.22	0.05	0.5	1.4				
12.24	0.05	0.4	1.4			0.5	
12.30	0.09	0.4	1.7				
12.32	0.09	0.5	2.0				
12.34	0.09	0.4	1.6			0.5	
13.24	0.07	0.5	1.7		0.9	0.2	
13.27	0.05	0.4	1.4		2.2		
13.36	0.08	0.5	1.3	0.3	0.7		Cu: 0.5
with OK Tubrod							
14.00S	0.05	0.4	1.6				
14.07S	0.05	0.4	0.9	1.3		0.5	
15.00S	0.06	0.5	1.6				
15.24S	0.08	0.5	1.9		0.8		

Typical weld metal mechanical properties, DC+

	ReL / Rp0.2 (MPa)	Rm (MPa)	A4 / A5 (%)	CVN (J at °C)			AW/ SR	Remarks
With OK Autrod								
				-20	-30	-40	-46	
12.10	360	465	30	95	75	65		AW
12.20	410	510	29	80		55		AW
12.22	425	520	29	100		60	40	AW
12.24	500	580	24	60	35			AW
12.30	480	580	29	90	60			AW
12.32	480	580	28	95		65	40	AW
12.34	535	620	27	70	60	45		AW
13.24	560	630	25	85	70	60	40	AW
13.27	500	600	28	100		60		AW CVN at -51°C: 50 J
13.36	490	580	27	70	50			AW
13.64							50	AW CVN at -51°C: 40 J two-run-classification
with OK Tubrod								
14.00S	454	538	30	130				AW
14.07S	620	700	26					AW
15.00S	460	540	30			110		AW
15.24S	550	640	26			130		AW CVN at -51°C: 120 J
with OK Autrod								
12.10	330	430	32	90	75	60	35	SR
12.20	390	500	30	55		30		SR
12.22	390	500	32	80		65	45	SR
12.24	480	560	25	40				SR
12.30	450	550	29	85	50			SR
12.32	470	570	28	95		50	35	SR
12.34	505	605	26	55	35			SR
13.24	520	610	28	65	60	40		SR
13.27	460	550	29	105		60		SR CVN at -51°C: 50 J

For more information view the Product Data Sheets or contact ESAB.



vessels are- welded with this flux, because it can be used for a wide range of steels including low temperature steels. This reduces the number of different fluxes a customer needs to have in stock. Wind tower production with plate thicknesses of greater than 50mm require not only excellent slag detachability, particularly in the first run, and high deposition rates in all following runs, but also excellent toughness values. Since OK Flux 10.71 offers all this it is well established in this market segment.

Other applications include shipbuilding, where marine approvals are a necessity and the welding of pipes up to X70 strength level. OK Flux 10.71 can also be used in combination with a number of SAW cored wires in order to increase the productivity and the mechanical properties of the weld metal.

OK Flux 10.72 – Toughness to -50°C – not only for wind towers

OK Flux 10.72 is an agglomerated, basic flux, designed for the production of wind towers. It combines the high demands for multi-layer thick section welding, using high deposition rates with respectable toughness values down to -50°C when combined with a standard non-alloyed SAW wire.

It is used for single and multi-wire procedures such as tandem, twin-arc, tandem-twin welding, ICE™ process and many more, for butt and fillet welds. It works equally well on DC and AC current. The excellent slag removal in narrow V-joints allows the included angle of the joint to be reduced. OK Flux 10.72 can be applied for unlimited plate thicknesses.

In wind tower production, plate thicknesses of 50mm and above are common, generally welded with Y-joints. It is essential that the slag is easily removable on the first run. For the remaining filling passes the flux needs to offer a high current carrying capacity, to allow for high deposition rates, for example, 38kg/h with the tandem-twin process. Often toughness values down to -50°C are required throughout the thickness. This excellent flux can also be utilised in other market segments with similar welding requirements e.g. pressure vessels and general construction welding.

OK Flux 10.72 has passed CTOD tests

with the following wire:

OK Autrod 13.27 at -10°C

Classification flux	Basicity index	Density	Grain size
EN ISO 14174: S A AB 1 57 AC H5	1.9	~ 1.2 kg/dm ³	0.315 - 2.0 mm

Slag type	Polarity	Alloy transfer	Hydrogen
Aluminate-basic	DC+ / AC	No Si and moderately Mn alloying	≤ 5 HDM

Flux consumption kg flux / kg wire

Voltage	DC+	AC
26	0.7	0.6
30	1.0	0.9
34	1.3	1.2
38	1.6	1.4

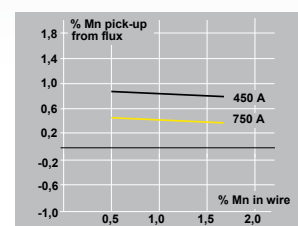
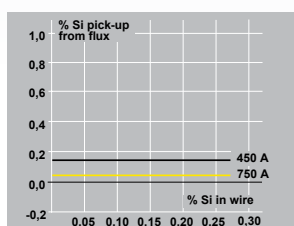

Single wire, ø 4.0 mm, DC+, 30 V, 60 cm/min

Classification

Wire	Weld metal
OK Autrod EN / AWS	EN / AW AWS / AW AWS / PWHT
12.20 S2 / EM12	S 38 5 AB S2 A5.17: F7A8-EM12 A5.17: F6P8-EM12
12.22 S2Si / EM12K	S 38 5 AB S2Si A5.17: F7A8-EM12K A5.17: F6P8-EM12K
12.24 S2Mo; S S Mo / EA2	S 46 3 AB S2Mo A5.23: F8A5-EA2-A3 A5.23: F8P5-EA2-A3
13.27 S2Ni2 / ENi2	S 46 6 AB S2Ni2 A5.23: F8A8-ENi2-Ni2 A5.23: F7P8-ENi2-Ni2
13.64 S2MoTiB / EA2TiB	A5.23: F8TA8-EA2TiB

Approvals

	ABS	BV	DNV-GL	LR	TÜV	DB	CE
OK Flux 10.72						x	x
with OK Autrod							
12.20					x	x	x
12.22			IV YM (-50°C)*		x	x	x
12.24					x	x	x
13.27							x

* Selected production units only

Typical weld metal chemical composition (%), DC+

	C	Si	Mn	Cr	Ni	Mo	Other
With OK Autrod							
12.20	0.05	0.2	1.5				
12.22	0.05	0.3	1.5				
12.24	0.05	0.2	1.6			0.5	
13.27	0.05	0.3	1.4		2.2		

Typical weld metal mechanical properties, DC+

	ReL / Rp0.2 (MPa)	Rm (MPa)	A4 / A5 (%)	CVN (J at °C)	AW/SR	Remarks
With OK Autrod						
12.20	415	500	30	125	70 50	AW
12.22	415	500	30	120	70 50	AW
12.24	500	590	25	60 35		AW
13.27	490	610	30		80 50	AW
13.64					50	AW two-run-classification
12.20	360	460	32	130	70 50	SR
12.22	360	460	32	130	70 50	SR
12.24	490	580	25	60 35		SR
13.27	450	560	32		90 60	SR

For more information view the Product Data Sheets or contact ESAB.



OK Flux 10.72 - Wind towers, pressure vessels and general construction



OK Flux 10.72 is designed for multi-run fillet and butt welding and provides reliable low-temperature toughness at -50°C , using standard un-alloyed wire OK Autrod 12.20 or 12.22. It suits all common SAW variants – single wire, twin-arc and tandem – and offers a tempting potential for fabricators to increase productivity further with four-wire, tandem-twin arc welding and the ICE™ process. The flux is well established in wind tower fabrication, but also in the manufacturing of pressure vessels, penstocks and in general fabrication.

Tandem-twin – a major step forward.

The development of tandem-twin SAW coincided with the development of OK Flux 10.72. The process brings welding productivity to new levels. It can be used for all welds with the accessibility to accommodate tandem-twin equipment – most importantly the circumferential welds that make up the majority in wind tower fabrication. OK Flux 10.72 is capable of accommodating the high deposition rate of the tandem-twin process. The table on this page compares the deposition rates for various SAW techniques and shows the superior productivity from the tandem-twin process.



Because of the excellent slag detachability of OK Flux 10.72 in narrow joints, productivity can be dramatically improved by reducing the joint angle from 60° to 50° . Comparing a Y- 60° joint in 35mm plate welded with tandem SAW with a Y- 50° joint welded with tandem twin (19% joint volume reduction), it can be calculated that the arc time is almost halved (see Svetsaren 2/2005 p.16).

Comparison of deposition rates for various SAW techniques

SAW process	Wire combination	Deposition rate at 100% duty cycle
Single wire	1 x 4.0 mm	12 kg/h
Twin-wire	2 x 2.5 mm	15 kg/h
Tandem wire	2 x 4.0 mm	25 kg/h
Tandem-Twin	4 x 2.5 mm	38 kg/h
Single ICE™	4 + 3 x 2.5 mm	40 kg/h

Reduction of joint cross section by reduced opening angle, using OK Flux 10.72

Plate thickness	Cross section Y- joint 60°	Cross section Y- joint 50°	Reduction
(mm)	5mm land, no gap (mm ²)	5mm land, no gap (mm ²)	(%)
25	231	187	-19
35	520	420	-19
45	924	746	-19



OK Flux 10.74 – Pipemill flux for longitudinal, multi-wire welding

Classification flux	Basicity index	Density	Grain size
EN ISO 14174: S A AB 1 67 AC H5	1.4	~ 1.2 kg/dm ³	0.2 - 2.0 mm

Slag type	Polarity	Alloy transfer	Hydrogen
Aluminate-basic	DC+ / AC	Slightly Si and moderately Mn alloying	≤ 5 HDM

Flux consumption kg flux / kg wire

Voltage	DC+	AC
26	0.7	0.6
30	1.0	0.9
34	1.3	1.2
38	1.6	1.4

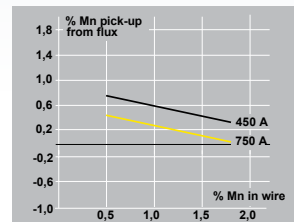
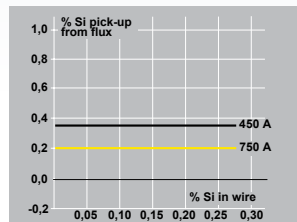

Single wire, ø 4.0 mm, DC+, 30 V, 60 cm/min

Classification

Wire	Weld metal
OK Autrod EN / AWS	EN / AW AWS / AW AWS / PWHT
12.20 S2 / EM12	S 42 4 AB S2 A5.17: F7A6-EM12 A5.17: F6P6-EM12
12.22 S2Si / EM12K	S 42 4 AB S2Si A5.17: F7A6-EM12K A5.17: F6P6-EM12K
12.24 S2Mo; S S Mo / EA2	S 46 2 AB S2Mo A5.23: F8A2-EA2-A4 A5.23: F7P0-EA2-A4
12.34 S3Mo; S S MnMo / EA4	S 50 2 AB S3Mo A5.23: F9A2-EA4-A3 A5.23: F9P0-EA4-A3
13.64 S2MoTiB / EA2TiB	A5.23: F8TA6-EA2TiB

Typical weld metal chemical composition (%), DC+

	C	Si	Mn	Cr	Ni	Mo	Other
With OK Autrod							
12.20	0.07	0.3	1.5				
12.22	0.07	0.5	1.5				
12.24	0.05	0.4	1.4			0.5	
12.34	0.08	0.4	1.6			0.5	

Typical weld metal mechanical properties, DC+

	ReL / Rp0.2 (MPa)	Rm (MPa)	A4 / A5 (%)	CVN (J at °C)	AW/ SR	Remarks
With OK Autrod				-18 -20 -40 -51		
12.20	440	540	30		AW	
12.22	440	540	30		AW	
12.24	520	590	24	65	AW	CVN at -29°C: 50 J
12.34	590	670	24	60 55	AW	CVN at -29°C: 40 J
13.64					70 AW	two-run-classification

For more information view the Product Data Sheets or contact ESAB.

OK Flux 10.74 is an agglomerated, basic flux designed primarily for multi-wire procedures in the production of longitudinal welded line pipes.

The flux alloys some Si and Mn to the weld metal and works equally well on DC and AC current. It provides excellent weldability when used with SAW processes using at least 3 independent wires.

OK Flux 10.74 produces a low bead profile in longitudinal line pipe welding at high welding speeds. A low profile without peaks decreases pipe coating costs because coating thicknesses can be reduced. With various wires, OK Flux 10.74 is suited for all pipe steels. When used in combination with the Ti-B micro alloyed wire, OK Autrod 13.64, outstanding toughness levels are achieved. Due to the careful metallurgical design OK Flux 10.74 produces a weld metal free of hard spots.

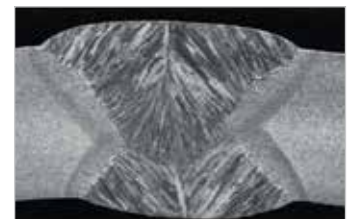

OK Flux 10.77 – Spiral pipemill flux for high speed welding

OK Flux 10.77 is an agglomerated, basic flux designed primarily for multi-wire procedures in the production of spiral welded line pipes.

The flux alloys some Si and Mn to the weld metal and it works equally well on DC and AC current. It is used in single wire, tandem and 3 wire systems and it is also suitable for longitudinal welded pipes of limited plate thicknesses.

OK Flux 10.77 produces welded joints with shallow reinforcement, low transition angles and smooth surface finish even at high welding speeds. A shallow reinforcement means cost saving in the later pipe coating operation, since the coating thickness can be reduced. With different wires it is suitable for all mild and high strength line pipe steels.



Classification flux	Basicity index	Density	Grain size
EN ISO 14174: S A AB 1 67 AC H5	1.3	~ 1.2 kg/dm ³	0.2 - 1.6 mm

Slag type	Polarity	Alloy transfer	Hydrogen
Aluminate-basic	DC+ / AC	Slightly Si and moderately Mn alloying	≤ 5 HDM

Flux consumption kg flux / kg wire

Voltage	DC+	AC
26	0.7	0.6
30	1.0	0.9
34	1.3	1.2
38	1.6	1.4

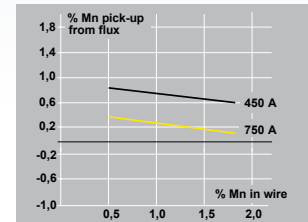
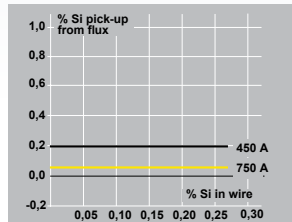

Single wire, ø 4.0 mm, DC+, 30 V, 60 cm/min

Classification

Wire	Weld metal			
OK Autrod	EN / AWS	EN / AW	AWS / AW	AWS / PWHT
12.20	S2 / EM12	S 38 4 AB S2	A5.17: F7A4-EM12	A5.17: F6P4-EM12
12.22	S2Si / EM12K	S 38 4 AB S2Si	A5.17: F7A5-EM12K	A5.17: F6P5-EM12K
12.24	S2Mo; S S Mo / EA2	S 46 2 AB S2Mo	A5.23: F8A4-EA2-A2	A5.23: F7P2-EA2-A2
12.34	S3Mo; S S MnMo / EA4	S 50 3 AB S3Mo	A5.23: F8A4-EA4-A4	A5.23: F8P2-EA4-A4
13.64	S2MoTiB / EA2TiB		A5.23: F8TA6-EA2TiB	

Approvals

	ABS	BV	DNV-GL	LR	TÜV	DB	CE
OK Flux 10.77							x
with OK Autrod							
12.20							x
12.22							x
12.24							x

Typical weld metal chemical composition (%), DC+

	C	Si	Mn	Cr	Ni	Mo	Other
With OK Autrod							
12.20	0.06	0.3	1.4				
12.22	0.07	0.4	1.4				
12.24	0.07	0.3	1.3			0.5	
12.34	0.08	0.3	1.5			0.5	

Typical weld metal mechanical properties, DC+

	ReL / Rp0.2 (MPa)	Rm (MPa)	A4 / A5 (%)	CVN (J at °C)	AW/SR	Remarks
With OK Autrod				-20 -29 -40	-46	
12.20	420	500	28	80 65 55	AW	
12.22	420	520	26	130 110 80	50 AW	
12.24	495	580	25	60 50 40	AW	
12.34	540	630	25	70 60 45	AW	
13.64					65 AW	CVN at -51°C: 60 J two-run-classification

For more information view the Product Data Sheets or contact ESAB.

**OK Flux 10.71, 10.74 and 10.77 -
for double-sided longitudinal and
spiral welded pipes**

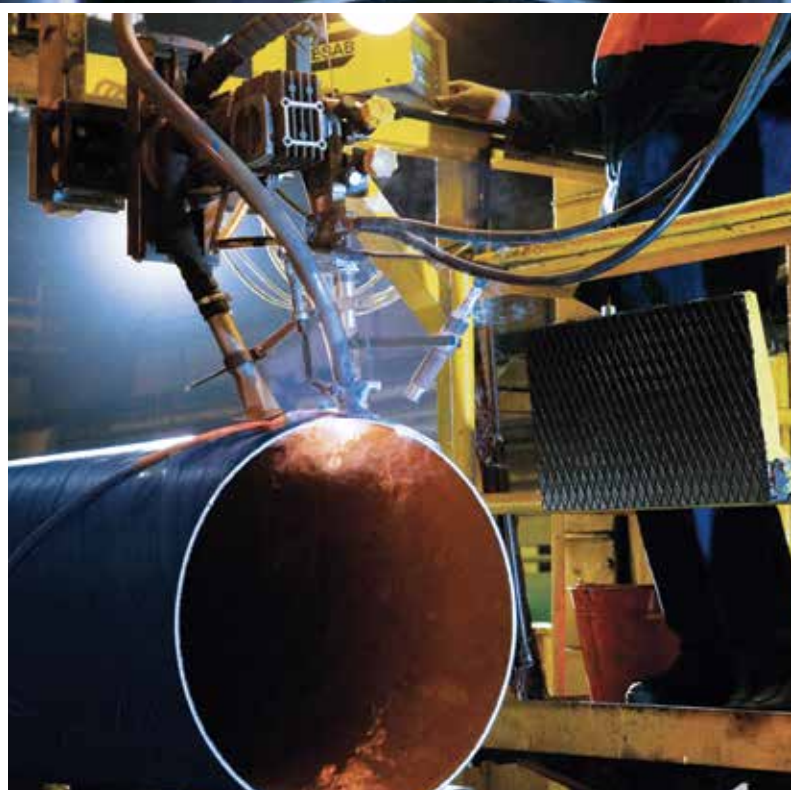

OK Flux 10.76 – For high dilution applications

OK Flux 10.76 is an agglomerated, basic flux for submerged arc welding. It is especially suited for welding joints with high dilution, such as I-joints with one run from each side and fillet welds. Due to its high alloying of mainly Mn, it creates a weld metal with outstanding toughness values in these joint types.

It is used for single and multi-wire procedures and works equally well on DC and AC current. On multi-pass welding the number of passes is limited and plate thicknesses of around 20mm should not be exceeded. OK Flux 10.76 is recommended to be used with OK Autrod 12.10.

The main application area for OK Flux 10.76 is in shipbuilding, where it is used preferably for two run double-sided welding. However it is also used in other application areas such as pressure vessels, transport and general construction where joints with high dilution or a limited number of passes are welded.

Classification flux	Basicity index	Density	Grain size
EN ISO 14174: S A AB 1 89 AC	1.5	~ 1.2 kg/dm ³	0.2 - 1.6 mm

Slag type	Polarity	Alloy transfer
Aluminate-basic	DC+ / AC	High Si and very high Mn alloying

Flux consumption kg flux / kg wire

Voltage	DC+	AC
26	0.7	0.6
30	1.0	0.9
34	1.3	1.2
38	1.6	1.4

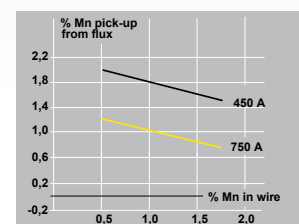
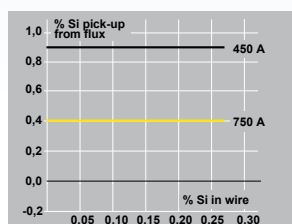

Single wire, ø 4.0 mm, DC+, 30 V, 60 cm/min

Classification

	Wire	Weld metal		
OK Autrod	EN / AWS	EN / AW	AWS / AW	AWS / PWHT
12.10	S1 / EL12	S 42 3 AB S1	A5.17: F7A4-EL12	A5.17: F7P4-EL12

Approvals*

	ABS	BV	DNV-GL	LR	TÜV	DB	CE
OK Flux 10.76 with OK Autrod						x	x
12.10	3YTM	3YTM	III YTM	3YTM		x	x

*For a full approval listing, view the Product Data Sheet or contact ESAB

Typical weld metal chemical composition (%), DC+

With OK Autrod	C	Si	Mn	Cr	Ni	Mo	Other
With OK Autrod 12.10	0.06	0.5	1.9				

Typical weld metal mechanical properties, DC+

	ReL / Rp0.2 (MPa)	Rm (MPa)	A4 / A5 (%)	CVN (J at °C)			AW/SR
With OK Autrod				0	-20	-30	-40
12.10	450	540	25	100	70	55	45 AW
12.10	420	520	25	90	65		40 SR

For more information view the Product Data Sheets or contact ESAB.

OK Flux 10.80 – A highly active flux

Classification flux	Basicity index	Density	Grain size
EN ISO 14174: S A CS 1 89 AC	1.1	~ 1.1 kg/dm ³	0.2 - 1.6 mm

Slag type	Polarity	Alloy transfer
Calcium-silicate	DC+ / AC	High Si and very high Mn alloying

Flux consumption kg flux / kg wire

Voltage	DC+	AC
26	0.6	0.5
30	0.9	0.7
34	1.2	1.0
38	1.5	1.3

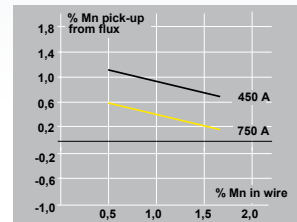
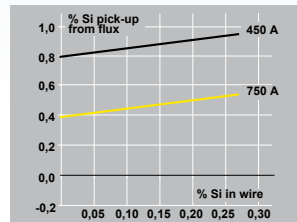

Single wire, ø 4.0 mm, DC+, 30 V, 60 cm/min

Classification

Wire	Weld metal
OK Autrod	EN / AWS EN / AW AWS / AW AWS / PWHT
12.10	S1 / EL12 S 38 0 CS S1 A5.17: F7A2-EL12 A5.17: F6P0-EL12
12.20	S2 / EM12 S 42 0 CS S2 A5.17: F7A2-EM12 A5.17: F6P0-EM12
12.22	S2Si / EM12K A5.17: F7A2-EM12K A5.17: F6P0-EM12K

Approvals

	ABS	BV	DNV-GL	LR	TÜV	DB	CE
OK Flux 10.80						x	x
with OK Autrod							
12.10					x	x	x
12.20					x	x	x

Typical weld metal chemical composition (%), DC+

	C	Si	Mn	Cr	Ni	Mo	Other
With OK Autrod							
12.10	0.07	0.7	1.4				
12.20	0.09	0.6	1.7				
12.22	0.07	1.0	1.5				

Typical weld metal mechanical properties, DC+

	ReL / Rp0.2 (MPa)	Rm (MPa)	A4 / A5 (%)	CVN (J at °C)	AW/SR	Remarks
With OK Autrod				+20 0 -18	-29	
12.10	410	520	28	110 80	40	AW
12.20	440	550	29	90 70	40	AW
12.22	440	550	30		60 45	AW
12.10	370	500	30	100 70	45	SR
12.20	400	540	30	80 60	40	SR
12.22	370	520	30		35 30	SR

For more information view the Product Data Sheets or contact ESAB.

OK Flux 10.80 is an agglomerated, neutral-basicity flux for submerged arc welding. It alloys a lot of Si and Mn to the weld metal and thus is suited for single and limited pass butt welds and for surfacing tasks.

It is welded with single and multi-wire procedures, with either DC or AC current. Due to the high alloying the flux is intended for plate thickness up to approximately 20mm in joining applications.

OK Flux 10.80 is used in general construction, pressure vessel industries and others. It is appreciated for surface build-up jobs such as the repair of diesel engine pistons, because hardness of the weld metal is increased due to the high alloying.



OK Flux 10.81 – For smooth weld beads and nicely formed, concave fillet welds

OK Flux 10.81 is an agglomerated, low-basicity flux. The benefits of this flux are the smooth surface finish and excellent slag detachability. It is intended for a limited number of passes and plate thickness up to approx. 25mm.

It is used for single and multi-wire procedures such as tandem and twin-arc welding. Concave fillet welds with an excellent washing on the sidewalls are created with this flux as well as attractive butt and overlap welds. It works equally well on DC and AC current and the high alloying of Si makes it well suited for high speed welding.

Classification flux	Basicity index	Density	Grain size
EN ISO 14174: S A AR 1 97 AC	0.6	~ 1.2 kg/dm ³	0.2 - 1.6 mm, 0.2 - 1.25 mm

Slag type	Polarity	Alloy transfer
Aluminate-rutile	DC+ / AC	Very high Si and moderately Mn alloying

Flux consumption kg flux / kg wire

Voltage	DC+	AC
26	0.7	0.6
30	1.0	0.9
34	1.3	1.2
38	1.6	1.4

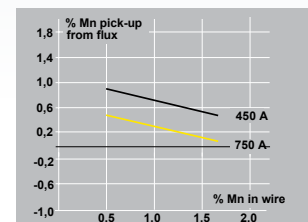
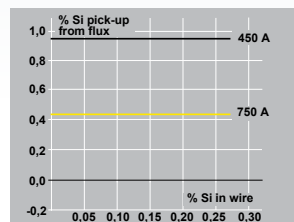

Single wire, ø 4.0 mm, DC+, 30 V, 60 cm/min

Classification

	Wire	Weld metal		
OK Autrod	EN / AWS	EN / AW	AWS / AW	AWS / PWHT
12.10	S1 / EL12	S 42 A AR S1	A5.17: F7AZ-EL12	A5.17: F7PZ-EL12
12.20	S2 / EM12	S 46 0 AR S2	A5.17: F7A0-EM12	A5.17: F7PZ-EM12
12.22	S2Si / EM12K	S 50 A AR S2Si	A5.17: F7AZ-EM12K	A5.17: F7PZ-EM12K
12.24	S2Mo; S S Mo / EA2	S 50 A AR S2Mo	A5.23: F9AZ-EA2-A4	A5.23: F9PZ-EA2-A4
12.30	S3	S 50 0 AR S3		
13.10 SC	S S CrMo1 / EB2R			A5.23: F9PZ-EB2R-G
13.36	S2Ni1Cu / EG	S 50 A AR S2Ni1Cu	A5.23: F9A0-EG-G	

Approvals

	ABS	BV	DNV-GL	LR	TÜV	DB	CE
OK Flux 10.81						x	x
with OK Autrod							
12.10					x	x	x
12.20	2YTM	2YTM	II YTM	2YTM	x	x	x
12.22							x
12.24					x		
12.30					x	x	x
13.10 SC					x		
13.36							x

Typical weld metal chemical composition (%), DC+

	C	Si	Mn	Cr	Ni	Mo	Other
With OK Autrod							
12.10	0.06	0.8	1.2				
12.20	0.07	0.8	1.5				
12.22	0.07	0.9	1.5				
12.24	0.07	0.8	1.5			0.5	
12.30	0.08	0.7	1.7				
13.10 SC	0.06	0.9	1.4	1.0		0.5	
13.36	0.07	0.9	1.4	0.3	0.7		Cu: 0.5

Typical weld metal mechanical properties, DC+

	ReL / Rp0.2 (MPa)	Rm (MPa)	A4 / A5 (%)	CVN (J at °C)		AW/ SR	
With OK Autrod				+20	0	-18	
12.10	450	540	25	50	30	AW	
12.20	510	610	25	80	60	40	AW
12.22	530	610	24	60		AW	
12.24	565	660	23	65	45	AW	
12.30	540	640	25	80	60	AW	
13.36	570	680	23	55	40	35	AW
12.10	420	520	27	45		SR	
12.20	440	550	25	50	40	SR	
12.22	500	590	27	50		SR	
12.24	555	650	22	55	40	SR	
12.30	500	610	24	70	50	SR	
13.10 SC	650	730	22	30		SR	

For more information view the Product Data Sheets or contact ESAB.



Downhand (PA/1F) fillet weld showing perfect wetting and smooth finish.

Due to its good weldability, OK Flux 10.81 is often used in the production of pressure vessels and spiral welded water pipes. The excellent sidewall wetting, which is preferred for dynamic loads in horizontal fillet welds is made use of in general construction, beam fabrication and the automotive industry. Very smooth transition angles in tube to fin joints for membrane wall panels are achieved with the especially created fine grained version. In many applications where the appearance of the weld bead or the excellent washing on the sidewalls in fillet welds are the main requirements, OK Flux 10.81 is chosen.

OK Flux 10.81 – For power generation, beam fabrication, automotive industry, general construction



Top class finished welds, excellent slag detachability and high welding speeds are only some of the attributes OK Flux 10.81 offers. In fillet welds, OK Flux 10.81 shows very good side wall wetting, concave fillets with no risk of undercut on either plate; desired for e.g. in production of membrane wall panels for power plants in which the especially fine grained version of the flux is applied. Because the tubes are thin-walled and under pressure, no undercut is permitted.

Dynamic loads on constructions is another good reason to demand concave fillet welds. A well washed fillet weld gives a beneficial distribution of forces. Wheels for trucks, earth moving equipment and other heavy machinery are, therefore, welded with OK Flux 10.81. Also in beam fabrication, OK Flux 10.81 is utilised for its smooth fillet welds. The superior shape is achieved through a special formulation and low basicity, although there is a limitation on toughness values. Butt welds are made with OK Flux 10.81 in industries such as pressure vessel or spiral pipe production.



OK Flux 10.83 – Flux for high speed welding

Classification flux	Basicity index	Density	Grain size
EN ISO 14174: S A AR 1 85 AC	0.3	~ 1.2 kg/dm ³	0.2 - 1.6 mm

Slag type	Polarity	Alloy transfer
Aluminate-rutile	DC+ / AC	High Si, no Mn alloying

Flux consumption kg flux / kg wire

Voltage	DC+	AC
26	0.7	0.6
30	1.0	0.9
34	1.3	1.2
38	1.6	1.4

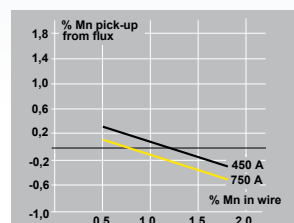
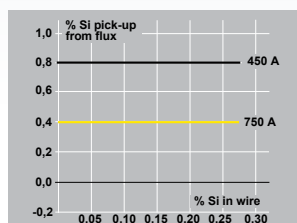

Single wire, ø 4.0 mm, DC+, 30 V, 60 cm/min

Classification

	Wire	Weld metal		
OK Autrod	EN / AWS	EN / AW	AWS / AW	AWS / PWHT
12.10	S1 / EL12	S 38 Z AR S1	A5.17: F7AZ-EL12	A5.17: F6PZ-EL12
12.22	S2Si / EM12K	S 42 Z AR S2Si	A5.17: F7AZ-EM12K	A5.17: F7PZ-EM12K

Approvals

	ABS	BV	DNV-GL	LR	TÜV	DB	CE
OK Flux 10.83							x
with OK Autrod							
12.22					x		x

Typical weld metal chemical composition (%), DC+

	C	Si	Mn	Cr	Ni	Mo	Other
With OK Autrod							
12.10	0.05	0.7	0.5				
12.22	0.05	0.8	0.9				

Typical weld metal mechanical properties, DC+

	ReL / Rp0.2 (MPa)	Rm (MPa)	A4 / A5 (%)	CVN (J at °C)	AW/ SR
With OK Autrod					
12.10	440	520	30	30	AW
12.22	470	560	26	50	AW
12.10	400	510	30		SR
12.22	440	560	29	50	SR

For more information view the Product Data Sheets or contact ESAB.

OK Flux 10.83 is an agglomerated, low-basicity flux for submerged arc welding. Highest welding speeds can be obtained with wire diameters of 3.0mm or less with this flux. Further attributes include smooth weld beads and excellent slag detachability.

It is used for single pass butt, overlap and fillet welds at high travel speeds and works equally well on DC and AC current, primarily used with single or twin-arc wire systems.

High welding speeds are applied e.g. in long weld runs for general construction, beam fabrication, membrane wall panel tube to fin welding and in the automotive industry for the production of car and truck wheels. In all these applications OK Flux 10.83 is used, when no impact toughness is required.

OK Flux 10.87 – High speed flux with perfect wetting

OK Flux 10.87 is an agglomerated, low-basicity flux for submerged arc welding. It gives perfect wetting and excellent weld bead appearance in butt, overlap and fillet welds at high welding speeds.

OK Flux 10.87 is used for single and multi-wire procedures and works equally well on DC and AC current. It is intended for a limited number of passes and plate thickness up to 25mm.

The main application area for OK Flux 10.87 is in the production of air compressor tanks, LPG bottles and fire extinguishers. A flat weld bead with a smooth, clean surface and excellent slag detachability is achieved, even when the second run has been pre-heated by the first run. Other industries with similar requirements also make use of OK Flux 10.87, including general construction and the automotive industry.

Classification flux	Basicity index	Density	Grain size
EN ISO 14174: S A AR 1 95 AC	0.4	~ 1.2 kg/dm ³	0.2 - 1.6 mm

Slag type	Polarity	Alloy transfer
Aluminate-rutile	DC+ / AC	Very high Si alloying, neutral on Mn

Flux consumption kg flux / kg wire

Voltage	DC+	AC
26	0.6	0.5
30	0.9	0.7
34	1.2	1.0
38	1.5	1.3

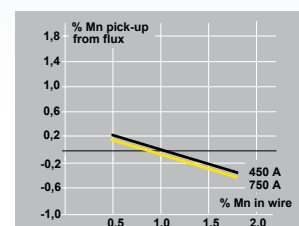
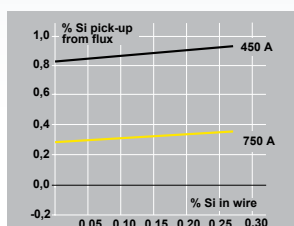

Single wire, ø 4.0 mm, DC+, 30 V, 60 cm/min

Classification

	Wire	Weld metal		
OK Autrod	EN / AWS	EN / AW	AWS / AW	AWS / PWHT
12.10	S1 / EL12	S 35 A AR S1	A5.17: F6AZ-EL12	A5.17: F6PZ-EL12
12.20	S2 / EM12	S 42 A AR S2	A5.17: F7AZ-EM12	A5.17: F6PZ-EM12
12.22	S2Si / EM12K	S 42 A AR S2Si	A5.17: F7AZ-EM12K	A5.17: F6PZ-EM12K

Typical weld metal chemical composition (%), DC+

	C	Si	Mn	Cr	Ni	Mo	Other
With OK Autrod							
12.10	0.05	0.8	0.6				
12.20	0.05	0.8	1.0				
12.22	0.05	0.9	1.0				

Typical weld metal mechanical properties, DC+

	ReL / Rp0.2 (MPa)	Rm (MPa)	A4 / A5 (%)	CVN (J at °C)	AW/ SR	
With OK Autrod				+20	0	
12.10	370	470	25	50	25	AW
12.20	410	500	25	50	25	AW
12.22	420	510	25	50	25	AW
12.10	345	445	25	50	25	SR
12.20	360	480	25	50	25	SR
12.22	400	490	25	50	25	SR

For more information view the Product Data Sheets or contact ESAB.

Overlap welds on thin material; also butt and fillet welds



The typical plate thickness for air compression tanks and gas bottles is 2.5mm. The overlap joints are SA welded with 1.2 to 2.5mm diameter wires.

Wires of diameter 2.0mm and less are available in 450 kg Marathon Pacs which increases productivity drastically by reducing the downtime for spool changes. A good weld bead appearance is just as important as the excellent slag removal which is evident even on a second pass welded over a hot first pass. With OK Flux 10.87 these requirements are fulfilled even at high welding speeds up to 2m/min. Wide weld beads are produced with low transition angles to the base material. OK Flux 10.87 should not be used when weld metal toughness requirements are specified.

OK Flux 10.88 – High tolerance for rust and mill scale, for -20°C applications

OK Flux 10.88 is an agglomerated, low-basicity flux for submerged arc welding. If welding is to be done without removing the heavy mill scale or rust from the welding area then this flux is the correct one to choose. Furthermore it produces a weld metal with toughness values down to -20°C when combined with a standard, non-alloyed wire.

The flux is designed for single layer and multi-layer welding of up to 30mm plate thickness. It works equally well on DC and AC current and is designed for butt, fillet and overlap welds. It can be used over a wide parameter range giving excellent slag removal and smooth weld bead surfaces.

OK Flux 10.88 is used in all application areas where severe plate surface conditions are found. This includes general constructions, beam fabrications, pressure vessels, shipbuilding and transport industries. Additionally, this flux is excellent on clean plates for its high resistance against porosity and its wide application field due to the toughness of the weld metal down to -20°C.

Classification flux	Basicity index	Density	Grain size
EN ISO 14174: S A AR 1 89 AC	0.7	~ 1.2 kg/dm ³	0.2 - 1.6 mm

Slag type	Polarity	Alloy transfer
Aluminate-rutile	DC+ / AC	High Si and very high Mn alloying

Flux consumption kg flux / kg wire

Voltage	DC+	AC
26	0.6	0.5
30	0.9	0.7
34	1.2	1.0
38	1.5	1.3

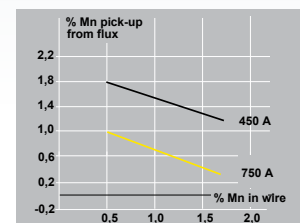
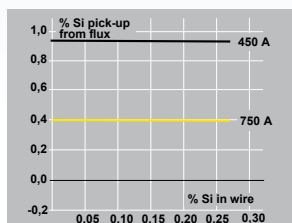

Single wire, ø 4.0 mm, DC+, 30 V, 60 cm/min

Classification

	Wire	Weld metal		
OK Autrod	EN / AWS	EN / AW	AWS / AW	AWS / PWHT
12.10	S1 / EL12	S 38 0 AR S1	A5.17: F6AZ-EL12	
12.20	S2 / EM12	S 42 2 AR S2	A5.17: F7A0-EM12	
12.22	S2Si / EM12K	S 42 2 AR S2Si	A5.17: F7A0-EM12K	A5.17: F6P0-EM12K

Approvals*

	ABS	BV	DNV-GL	LR	TÜV	DB	CE
With OK Autrod							
12.22	3Y400M						

* Selected production units only

Typical weld metal chemical composition (%), DC+

	C	Si	Mn	Cr	Ni	Mo	Other
With OK Autrod							
12.10	0.05	0.6	1.7				
12.20	0.05	0.6	1.8				
12.22	0.05	0.7	1.8				

Typical weld metal mechanical properties, DC+

	ReL / Rp0.2 (MPa)	Rm (MPa)	A4 / A5 (%)	CVN (J at °C)	AW/ SR	Remarks
With OK Autrod				0	-18	
12.10	400	470	30	45	AW	
12.20	430	520	25	70	AW	
12.22	440	510	26	70	AW	
12.22	390	470	25	60	SR	

For more information view the Product Data Sheets or contact ESAB.

Heavy mill scale - not all fabricators remove it from the weld area



OK FLUX 10.88 ON RUSTY PLATE WITH MILL SCALE. POROSITY-FREE, SHINY WELD APPEARANCE. CLEAN WELD WITH NO INDICATION OF SLAG RESIDUES ADHERED ONTO THE BEAD OR ALONG THE TOES OF THE WELD.

If you need to weld plate with rust, mill scale, moisture or dirt, then OK Flux 10.88 is the flux to use. Welds produced with other fluxes will give pock marks and porosity.

OK Flux 10.88 is specifically designed to cope with poor surface conditions. It is tolerant to surface contaminants and gives a smooth, defect-free weld appearance, even at higher welding speeds. Due to its alloying concept, the plate thickness in multi layer welding is limited to around 30mm.

OK Flux 10.88 is an easy to weld rutile flux with a wide parameter envelope, giving -20°C toughness with standard C-Mn alloyed wires. It combines excellent weldability and slag detachability with sufficient toughness for many applications.

OK Flux 10.16 - All purpose flux for Ni-based wires and strips

OK Flux 10.16 is an agglomerated, fluoride basic flux for submerged arc welding specially designed for butt welding and overlay welding with nickel-based alloyed wire. Can also be used for overlay welding with nickel-based strips. It is primarily used for multi-run welding of thick section materials.

OK Flux 10.16 is suitable for single layer and multi-layer welding of unlimited plate thickness and for strip cladding. It can only be used on DC current when butt welding with nickel-based alloy wires. This flux has good weldability in the 2G/PC position and the well balanced flux composition minimises silicon transfer from the flux to the weld metal providing good mechanical properties, particularly good impact toughness reducing the risk of hot cracking. It is also suitable for submerged arc strip cladding with all grades of nickel-based strips.

Applications include components of chemical and petrochemical plants, offshore constructions and pressure vessels.

Classification flux	Basicity index	Density	Grain size
EN ISO 14174: S A FB 2 55 43 DC	2.4	~ 1.2 kg/dm ³	0.25 - 1.6 mm

Slag type	Polarity	Alloy transfer
Fluoride basic	DC+	Moderately manganese and silicon alloying

Flux consumption kg flux / kg wire

Voltage	DC+
26	0.5
30	0.6
34	0.8
38	1.0

Classification

Wire	
OK Autrod	EN / AWS
NiCr-3	S Ni6082 (NiCr20Mn3Nb) / ERNiCr-3
NiCrMo-3	S Ni6625 (NiCr22Mo9Nb) / ERNiCrMo-3
NiCrMo-13	S Ni6059 (NiCr23Mo16) / ERNiCrMo-13

Typical weld metal chemical composition (%), DC+

	C	Si	Mn	Cr	Ni	Mo	Other
With OK Autrod							
NiCr-3	0.01	0.3	3.2	19.0	Bal.		Nb: 2.3
NiCrMo-3	0.01	0.3	0.6	19.5	Bal.	8.5	Fe: 2.0, Nb+Ta: 3.0
NiCrMo-13	0.02	0.2	0.7	18.0	Bal.	16.5	Fe: 2.0 Nb+Ta: 0.1

Typical weld metal mechanical properties, DC+

	ReL / Rp0.2 (MPa)	Rm (MPa)	A4 / A5 (%)	CVN (J at °C)			
With OK Autrod				+20	-60	-140	-196
NiCr-3	360	600	41	140			100
NiCrMo-3	450	720	43			100	90
NiCrMo-13	490	730	44	80	75		60

For more information view the Product Data Sheets or contact ESAB.





OK Flux 10.90 – Flux for 9% Ni and Ni-based alloys reducing the risk of hot cracking

OK Flux 10.90 is an agglomerated, fluoride basic flux for submerged arc welding of 9% nickel steels, other high alloyed steels and nickel-based alloys. It is primarily used for multi-run welding of thick section materials.

It can be used for single and multi-layer welding of unlimited plate thickness for butt and fillet welds and works very well on DC current. The flux gives a good bead shape, and good slag detachability and also very good weldability in the 2G/PC position. The low Si addition during welding provides good mechanical properties, particularly good impact toughness. It is a chromium compensating flux, adding manganese and nickel. This minimises the risk of hot cracking, when welding with Ni-based consumables.

LNG storage tanks are welded with OK Flux 10.90 because of its good mechanical properties and, very importantly, the reduction of hot cracking risks. It is also used for welding of components of chemical and petrochemical plants, offshore constructions and pressure vessels.

Classification flux	Basicity index	Density	Grain size
EN ISO 14174: S A AF 2 55 53 MnNi DC	1.7	~ 1.0 kg/dm ³	0.2 - 1.6 mm

Slag type	Polarity	Alloy transfer
Fluoride basic	DC+	Cr compensating, Ni and Mn alloying

Flux consumption kg flux/kg wire

Voltage	DC+
26	0.5
30	0.6
34	0.8
38	1.0

Classification

EN / AWS classification wire	
OK Autrod	
310	S 25 20 / ER310
NiCr-3	S Ni6082 (NiCr20Mn3Nb) / ERNiCr-3
NiCrMo-3	S Ni6625 (NiCr22Mo9Nb) / ERNiCrMo-3
NiCrMo-4	S Ni6276 (NiCr15Mo16Fe6W4) / ERNiCrMo-4
NiCrMo-13	S Ni6059 (NiCr23Mo16) / ERNiCrMo-13

Approvals

	ABS	BV	DNV-GL	LR	TÜV	DB	CE
with OK Autrod							
NiCrMo-3			NV 5 Ni and NV 9 Ni				
NiCrMo-4			VL 1.5Ni up to VL 9Ni				

Typical weld metal chemical composition (%), DC+

	C	Si	Mn	Cr	Ni	Mo	Other
With OK Autrod							
310	0.07	0.4	3.2	25.5	20.5		
NiCr-3	<0.01	0.4	4.4	19.3	Bal.	0.1	Nb: 2.6
NiCrMo-3	0.01	0.2	1.7	21.0	Bal.	8.5	Fe: 2.0, Nb+Ta: 3.0
NiCrMo-4	0.01	0.2	2.2	15.0	Bal.	15.5	W: 3.4, Fe: 6.0
NiCrMo-13	0.01	0.2	3.0	22.0	Bal.	14.0	Fe: 3

Typical weld metal mechanical properties, DC+

	ReL / Rp0.2 (MPa)	Rm (MPa)	A4 / A5 (%)	CVN (J at °C)
With OK Autrod				+20 -196
310	390	570	34	85
NiCr-3	400	600	35	130
NiCrMo-3	440	720	42	100
NiCrMo-4	480	700	35	60
NiCrMo-13	470	675	46	70

For more information view the Product Data Sheets or contact ESAB.

The best flux for LNG applications



OK Flux 10.90, used for SAW with ESAB Circotech welding equipment, is the best solution for building large LNG storage tanks.

A major benefit is the excellent weldability - particularly slag release in the 2G/PC position - using DC current for single and multi layer welding of unlimited plate thickness.

The flux is chromium compensating and slightly manganese and nickel alloying, thereby minimising the risk of hot cracking. The low Si content provides good impact properties.

OK Flux 10.90 is applied for butt welds in 9% Ni steels on LNG projects, with Ni-based wires.



Furthermore, the flux is frequently used in combination with a range of Ni-based wires for welding Ni-based alloys with the same or similar composition.

Circotech is designed for the single or double-sided welding in the 2G/PC position, travelling over the top edge of the tank shell. The flux is supplied from a flux hopper onto a rotating rubber belt, which keeps the flux in place. From here, the excess flux is collected and re-circulated.

OK Flux 10.92 – All-purpose flux for submerged arc strip cladding and the welding of stainless steels

OK Flux 10.92 operates well on DC current for single and multi-layer welding of unlimited plate thicknesses and has good welding characteristics with easy slag removal. If used for strip cladding with austenitic stainless welding strips, OK Flux 10.92 gives a smooth bead appearance. The Cr content in the flux produces a higher ferrite content in the weld metal, thereby reducing the risk of hot cracking.

Application areas for this flux include chemical and petrochemical plants, offshore constructions, pressure vessels, storage tanks, chemical tankers, power generation, nuclear, pulp and paper, civil constructions and transport industries.

Classification flux	Basicity index	Density	Grain size
EN ISO 14174: S A CS 2 57 53 DC	1.0	~ 1.0 kg/dm ³	0.2 - 1.6 mm

Slag type	Polarity	Alloy transfer
Calcium silicate	DC+	Cr compensating

Flux consumption kg flux / kg wire

Voltage	DC+
26	0.4
30	0.5
34	0.7
38	0.9

Classification

	Wire
OK Autrod	EN / AWS
16.97	S 18 8 Mn
308L	S 19 9 L / ER308L
309L	S 23 12 L / ER309L
316L	S 19 12 3 L / ER316L
318	S 19 12 3 Nb / ER318
347	S 19 9 Nb / ER347

Approvals

	ABS	BV	DNV-GL	LR	TÜV	DB	CE
with OK Autrod							
308L					x		
316L					x		
318					x		
347					x		

Typical weld metal chemical composition (%), DC+

	C	Si	Mn	Cr	Ni	Mo	FN	Other
With OK Autrod								
16.97	0.04	0.9	5.0	18.8	8.5			
308L	<0.03	0.9	1.0	20.0	10.0			
309L	0.02	0.8	1.1	24.1	12.9			
316L	0.02	0.8	1.0	19.1	11.9	2.7		
318	0.04	0.5	1.2	18.5	12.0	2.6	9	Nb: 0.3
347	0.04	0.7	0.9	19.8	9.7		9	Nb: 0.5

Typical weld metal mechanical properties, DC+

	ReL / Rp0.2 (MPa)	Rm (MPa)	A4 / A5 (%)	CVN (J at °C)		
With OK Autrod				+20	-60	-110
16.97	450	630	42	60	45	
308L	365	580	38		60	50
309L	420	560	32	40		
316L	385	590	36		55	
318	440	600	42	100	90	40
347	470	640	35	65	55	40

For more information view the Product Data Sheets or contact ESAB.



ESAB STAINLESS FLUX PACKAGE

- OK Flux 10.93: Designed for butt and fillet welding of standard austenitic stainless steels and higher alloyed stainless steels.
- OK Flux 10.94: Cr compensating flux for applications when the higher amount of ferrite for improving of resistance to hot cracking is required.
- OK Flux 10.95: A flux specially suitable for applications that require lower ferrite content max. 3-6%. Low ferrite promotes better mechanical properties mainly higher impact values.
- OK Flux 10.99: AC flux in order to avoid magnetic arc blow and to improve toughness values with special stainless steel wires. Also very good for selected Nickel wire electrodes.

OK Flux 10.93 – ESAB’s number one for stainless steel and dissimilar joints

OK Flux 10.93 is an agglomerated, fluoride basic flux for submerged arc welding of stainless steels. It is used for single and multi-run welding of all plate thicknesses giving excellent welding characteristics. It can be combined with a wide range of stainless wires and is commonly used for butt and fillet welding of all standard austenitic and higher alloyed stainless steels.

The flux works very well on DC current and has good weldability in the 2G/PB position. It provides a very good slag detachability, a smooth surface finish and a great bead appearance. The low Si addition during welding provides good mechanical properties with particularly good impact toughness properties.

Classification flux	Basicity index	Density	Grain size
EN ISO 14174: S A AF 2 56 54 DC	1.9	~1.0 kg/dm ³	0.2 - 2.0 mm

Slag type	Polarity	Alloy transfer
Fluoride basic	DC+	None

Flux consumption kg flux / kg wire

Voltage	DC+
26	0.5
30	0.6
34	0.8
38	1.0

Classification

	Wire
OK Autrod	EN / AWS
16.38	S 20 16 3 Mn L
16.97	S 18 8 Mn / (ER307)
308H	S 19 9 H / ER308H
308L	S 19 9 L / ER308L
309L	S 23 12 L / ER309L
309MoL	S 23 12 L / (ER309LMo)
310MoL	S 25 22 2 N L / (ER310LMo)
312	S 29 9 / ER312
316H	S 19 12 3 H / ER316H
316L	S 19 12 3 L / ER316L
317L	S 18 15 3 L / ER317L
318	S 19 12 3 Nb / ER318
347	S 19 9 Nb / ER347
385	S 20 25 5 Cu L / ER385
410NiMo	S 13 4
2209	S 22 9 3 N L / ER2209
2307	S 23 7 N L
2509	S 25 9 4 N L / ER2594

Approvals*

	ABS	BV	DNV-GL	LR	TÜV	DB	CE
OK Flux 10.93						x	x
with OK Autrod							
16.97			SS/CMn				
308L	ER308L		VL 308L		x	x	x
309L	ER309L		VL 309L	SS/CMn Dup/CMn	x		x
316L	ER316L		VL 316L		x	x	x
318					x	x	x
347					x	x	x
385					x		
2209	Duplex	Duplex	Duplex	S31803	x		x
2509					x		x

* For a full approval listing, view the Product Data Sheet or contact ESAB

Typical weld metal chemical composition (%), DC+

	C	Si	Mn	Cr	Ni	Mo	N	FN	Other
With OK Autrod									
16.38	0.02	0.7	5.4	20.0	15.5	2.5	0.13	0	
16.97	0.06	1.2	6.3	18.0	8.0				
308H	0.05	0.6	1.5	19.9	9.9			10	
308L	<0.03	0.6	1.4	19.5	10.0			8	
309L	<0.03	0.5	1.3	23.0	12.5				
309MoL	0.02	0.5	1.5	20.8	14.5	2.8			
310MoL	0.02	0.1	4.0	24.5	22.0	2.1	0.12	0	
312	0.10	0.5	1.5	29.0	9.5			50	
316H	0.05	0.6	1.5	19.0	12.5	2.2			
316L	<0.03	0.5	1.4	18.0	12.5	2.6		8	
317L	<0.04	0.5	1.5	18.5	13.5	3.2			
318	<0.04	0.5	1.2	18.5	12.0	2.6		9	Nb: 0.3
347	0.04	0.5	1.1	19.2	9.6			8	Nb: 0.5
385	<0.03	0.6	1.5	19.0	25.0	4.0		0	Cu: 1.5
410NiMo	0.02	0.5	0.4	11.7	4.1	0.51			
2209	0.02	0.5	1.3	22.5	9.0	3.1	0.17	45	
2307	<0.02	0.7	1.1	22.5	7.5	0.3	0.12	40	
2509	0.02	0.5	0.4	23.5	10.0	3.5	0.19	40	

OK Flux 10.93 is one of the most commonly used fluxes for welding stainless and corrosion resistant steels. It is well established in chemical and petrochemical plants, offshore construction, pressure vessels, storage tanks, chemical tankers, power generation, nuclear, pulp and paper, civil constructions and transport industries. This is a flux particularly well suited for the joining of duplex 2205 stainless steels, for example in chemical tankers.

Typical weld metal mechanical properties, DC+

	ReL / Rp0.2 (MPa)	Rm (MPa)	A4 / A5 (%)	CVN (J at °C)					
With OK Autrod									
				+20	-20	-60	-110	-196	
16.38	410	600	44				70	60	40
16.97	400	600	45	60					
308L	400	560	38	100		65	55	40	
309L	430	570	33	90		70	60	35	
309MoL	400	600	38	120					
310MoL	335	575	42	120					
316L	390	565	42	100		90	75	40	
317L	440	615	28	80		50			
318	440	600	42	100		90	40		
347	455	635	36	105		85	60	30	
385	310	530	35	80					
410NiMo	900	1000	15.5		30				
410NiMo *	770	850	19		55				
410NiMo **	785	860	18		50				
2209	630	780	30	140		80			
2307	560	730	32	140		60			
2509	640	840	28	85					

* Stress Relieved 600°C/2h
 ** Stress Relieved 580°C/4h

For more information view the Product Data Sheets or contact ESAB.



OK Flux 10.94 – An efficient technical solution for super duplex and high ferrite applications

OK Flux 10.94 is an agglomerated, fluoride basic, chromium compensating flux for butt welding of stainless steels. Specially recommended for welding stainless steels when a higher ferrite content is required. Primarily recommended for multi-run welding of unlimited plate thickness.

This flux works well on DC current and provides good slag detachability and bead appearance. OK Flux 10.94 gives a higher ferrite content in the weld metal due to the chromium addition, reducing the risk of hot cracking. The low Si addition during welding provides good mechanical properties of the weld metal.

The flux is used in the chemical and petrochemical industries for the welding of pressure vessels, storage tanks and chemical tankers. Especially recommended for the joining of super duplex 2507 stainless steels, e.g. in offshore applications.

Classification flux	Basicity index	Density	Grain size
EN ISO 14174: S A AF 2 56 64 DC	1.9	~ 1.0 kg/dm ³	0.2 - 1.6 mm

Slag type	Polarity	Alloy transfer
Fluoride basic	DC+	Cr compensating

Flux consumption kg flux / kg wire

Voltage	DC+
26	0.5
30	0.6
34	0.8
38	1.0

Classification

	Wire
OK Autrod	EN / AWS
308L	S 19 9 L / ER308L
347	S 19 9 Nb / ER347
2509	S 25 9 4 N L / ER 2594

Typical weld metal chemical composition (%), DC+

	C	Si	Mn	Cr	Ni	Mo	N	FN	Other
With OK Autrod									
308L	0.02	0.5	1.4	20.0	9.5			11	
347	0.04	0.5	1.0	19.6	9.6			9	Nb: 0.5
2509	<0.04	0.5	0.5	25.5	9.5	3.5	0.20	50	

Typical weld metal mechanical properties, DC+

	ReL / Rp0.2 (MPa)	Rm (MPa)	A4 / A5 (%)	CVN (J at °C)
With OK Autrod				+20 -60 -110 -196
308L	400	560	40	85 60
347	455	620	38	100 70 50 30
2509	625	830	28	90 50

For more information view the Product Data Sheets or contact ESAB.



OK Flux 10.95 – Flux for high impact strength at low temperatures

Classification flux	Basicity index	Density	Grain size
EN ISO 14174: S A AF 2 56 44 Ni DC	2.0	~ 1.0 kg/dm ³	0.2 - 1.6 mm

Slag type	Polarity	Alloy transfer
Fluoride basic	DC+	Ni alloying

Flux consumption kg flux / kg wire

Voltage	DC+
26	0.5
30	0.6
34	0.8
38	1.0

Classification

	Wire
OK Autrod	EN / AWS
308L	S 19 9 L / ER308L

Typical weld metal chemical composition (%), DC+

	C	Si	Mn	Cr	Ni	Mo	N	FN	Other
With OK Autrod									
308L	<0.03	0.6	1.4	20.0	11.0		0.06	5	

Typical weld metal mechanical properties, DC+

	ReL / Rp0.2 (MPa)	Rm (MPa)	A4 / A5 (%)	CVN (J at °C)		
With OK Autrod				-60	-110	-196
308L	400	540	40	80	70	50

For more information view the Product Data Sheets or contact ESAB.



OK Flux 10.95 is an agglomerated, fluoride basic, nickel adding flux for butt and fillet welding of austenitic stainless steels, with AWS ER300 grade of wires. Especially recommended for the welding of stainless steels when good impact toughness at low temperatures is required. Primarily for multi-run welding.

The flux works very well on DC current, gives good slag detachability and a smooth surface finish. The Ni addition to the flux makes it especially suited for applications requiring lower ferrite content; max. 3-8%. The limited ferrite content and low Si addition during welding provides very good mechanical properties in the weld metal.

Because of the careful metallurgical design it is often used for chemical and petrochemical plants, power generation, offshore construction, pressure vessels, storage tanks, civil construction and transport industries.

OK Flux 10.99 - AC Flux for Stainless steels and Nickel alloys

OK Flux 10.99 is a neutral agglomerated, fluoride basic flux for submerged arc welding of stainless steels and selected Nickel alloys. It is used for multi-run welding of thick materials.

The flux is particularly suited for AC welding, thus avoiding any magnetic arc blow. However, it also works very well on DC+. It can be used for single layer and multi-layer welding of unlimited plate thickness. The flux gives a smooth bead surface and offers decent slag detachability. Since there is no alloying from the flux it can be applied also in those cases where there is no alloying permitted (i.e. in 5% Ni steel joining in combination with OK Autrod 16.38 for LPG storage tanks and in 9% Ni with OK Autrod NiCrMo-4 for LNG application).

AC welding with stainless steel wires is applied for various reasons (such as improved mechanical properties, increased deposition rate and avoidance of magnetic arc blow) in industries such as process industry for chemical and petrochemical, in pressure vessels, power generation, pulp and paper or other.

Classification flux	Basicity index	Density	Grain size
EN ISO 14174: S A FB 2 55 53 AC	2.5	~ 1.0 kg/dm ³	0.2 - 1.6 mm

Slag type	Polarity	Alloy transfer
Fluoride-basic	AC/DC+	None

Flux consumption kg flux / kg wire

Voltage	DC+	AC
26	0.7	0.6
30	0.8	0.8
34	0.9	1.1
38	1.1	1.3

Classification

EN/AWS classification wire	
OK Autrod	
16.38	S 20 16 3 Mn L
308L	S 19 9 L / ER308L
309L	S 23 12 L / ER309L
316L	S 19 12 3 L / ER316L
NiCrMo-4	S Ni 6276 (NiCr15Mo16Fe6W4) / ERNiCrMo-4

Typical weld metal chemical composition (%)

	C	Si	Mn	Cr	Ni	Mo	N	FN	Other	AC/DC+
With OK Autrod										
16.38	0.025	0.48	7.0	20.0	16.0	3.0	0.17	0	-	AC
308L	0.025	0.30	1.9	19.2	9.8	0.1	0.07	6	-	AC
308L	0.020	0.34	1.9	19.2	9.8	0.1	0.07	6	-	DC+
309L	0.030	0.35	1.9	22.0	13.0	0.1	0.09	-	-	AC
316L	0.025	0.35	1.7	18.3	12.0	2.6	0.05	6	-	AC
NiCrMo-4	0.015	0.08	0.7	15.2	Bal.	15.6	-	-	W: 3.7; Fe: 6.5	AC
NiCrMo-4	0.011	0.11	0.7	15.2	Bal.	15.6	-	-	W: 3.6; Fe: 6.5	DC+

Typical weld metal mechanical properties

	Rp0.2 (MPa)	Rm (MPa)	A4 / A5 (%)	VCN (J at °C)	AC/DC+
With OK Autrod					
16.38	420	630	40	-20 -40 -60 105	AC
308L	400	560	36	105 100 90	AC
308L	400	560	36	85 80 75 50	DC+
309L	410	575	36	105 100 95	AC
316L	410	570	35	110 105 100	AC
NiCrMo-4	480	720	42		AC
NiCrMo-4	480	720	42		DC+

For more information view the Product Data Sheet or contact ESAB.

General information pages



Product documents

Product Data Sheet
S 'Submerged arc welding'
OK Flux 10.72

Product Data Sheet
S 'Submerged arc welding'
OK Autrod 12.22

Product Data Sheet
S 'Submerged arc welding'
OK Flux 10.72/OK Autrod 12.22

INSPECTION CERTIFICATE
in accordance with EN 10204 - 3.1
Certificate number: EC23828934 rev. 0

All fluxes, wires and flux/wire combinations are supported by core documentation such as product data sheets (PDS), safety data sheets (SDS) and certificates.

SAFETY DATA SHEET
This Safety Data Sheet complies with Regulation (EC) No 1907/2006, 1272/2008, ISO 11014-1 and ANSI Z400.1

1. SECTION 1: IDENTIFICATION OF THE MIXTURE AND OF THE COMPANY

1.1. Product identifier: OK Autrod 12.22
Application: 1.2. Relevant identified uses of the substance or mixture and uses advised against: Arc Welding
Classification(s): EN ISO 14171-A: S2S SFA/AWS A5.17: EM12K
Supplier: 1.3. Details of the supplier of the safety data sheet: ESAB AB, Box 8004, 402 77 Göteborg, Sweden. sds.esab@esab.se Web site www.esab.com
Telephone no.: +46 31 509000
1.4. Emergency telephone number: +46 31 509000 office hours

2. SECTION 2: HAZARDS IDENTIFICATION

Emergency Overview: Metal wire or rods in varying colours. This product is normally not considered hazardous as shipped. Gloves should be worn when handling to prevent cuts and abrasions.
2.1. Classification of the substance or mixture: N.a.
2.2. Label elements: N.a.
2.3. Other hazards: N.a.
Persons with a pacemaker should not go near welding or cutting operations until they have consulted their doctor and obtained information from the manufacturer of the device.
When this product is used in a welding process, the most important hazards are welding fumes, heat, radiation and electric shock.
Fumes: Welding fumes are normally not a hazard with submerged arc welding, unless the arc burns through the flux bed. Use enough flux to avoid burn-through. Overexposure to welding fumes may result in symptoms like metal fume fever, dizziness, nausea, dryness or irritation of the nose, throat or eyes. Chronic overexposure to welding fumes may affect pulmonary function. Overexposure to manganese and manganese compounds above safe exposure limits can cause irreversible damage to the central nervous system, including the brain, symptoms of which may include slurred speech, lethargy, tremor, muscular weakness, psychological disturbances and spastic gait.
Heat: Spatter and molten metal can cause burn injuries and start fires.
Radiation: Arc rays can severely damage eyes or skin.
Electricity: Electric shock can kill.

3. SECTION 3: COMPOSITION/INFORMATION ON INGREDIENTS

3.2. Mixtures: This product is a continuous solid metal wire.

Wire Composition	Weight %	REACH Reg.#	CAS#	EC#	Haz. class.1	IARC2	NTP3	Haz. class.
Copper	+0.5	01-2179480-5	7440-50-6	231-158-6	No	-	-	-
Iron	+0.0	01-2179480-5	7439-89-6	251-096-4	No	-	-	-
Manganese	1-2	-24	7439-96-3	251-155-1	No	-	-	-

(1) Hazard Classification according to European Council Directive 67/548/EEC.
(2) Evaluation according to the International Agency for Research on Cancer.
(3) Classification according to the 118th Report on Carcinogens, published by the US National Toxicology Program. Carcinogen listing according to OSHA, (USA).
(4) Hazard Classification according to Regulation (EC) No 1272/2008.

4. SECTION 4: FIRST AID MEASURES

4.1. Description of first aid measures:
Inhalation: If breathing has stopped, perform artificial respiration and obtain medical assistance immediately! If breathing is difficult, provide fresh air and call physician.
Eye contact / Skin contact: For radiation burns due to arc flash, see physician. To remove dusts or fumes flush with water for at least fifteen minutes. If irritation persists, obtain medical assistance. For skin burns from arc radiation, promptly flush with cold water. Get medical attention for burns or irritations that persist. To remove dust or particles wash with mild soap and water.
Electric shock: Disconnect and turn off the power. Use a nonconductive material to pull victim away from contact with live parts or wires. If not breathing, begin artificial respiration, preferably mouth-to-mouth. If no detectable pulse, begin Cardio Pulmonary Resuscitation (CPR). Immediately call a physician.

4.2. Most important symptoms and effects, both acute and delayed: N.a. 4.3. Indication of any immediate medical attention and special treatment needed: N.a. General: Move to fresh air and call for medical aid.

5. SECTION 5: FIRE FIGHTING MEASURES

5.1. Extinguishing media: No specific recommendations for welding consumables. Welding arcs and sparks can ignite combustible and flammable materials. Use the extinguishing media recommended for the burning materials and fire situation. 5.2. Special hazards arising from the substance or mixture: N.a.

The submerged arc welding process

Submerged arc welding (SAW) is a method in which the heat required to fuse the metal is generated by an arc formed by an electric current passing between the electrode and the work-piece. A layer of granulated mineral material known as submerged arc welding flux covers the tip of the welding wire, the arc, and the work-piece. There is no visible arc and no sparks, spatter or fume. The electrode may be a solid or cored wire or a strip.

SAW is normally a mechanised process. The welding current, arc voltage, and travel speed all affect the bead shape, depth of penetration and chemical composition of the deposited weld metal. Since the operator cannot observe the weld pool, great reliance is placed on parameter setting and positioning of the electrode.

General scope:

- Current: the total welding current can range between 100 and 3600 amps
- Wires in one molten pool: from 1 to 6
- Voltage: 20 – 50 volts
- Speed: 30 – 350 cm/min
- Deposition rate: 2 – 100 kg/h

The welding operation

When the apparatus is set into operation, several things occur in quick sequence:

- The submerged arc welding flux feeds through the hopper tube and continuously distributes itself over the seam a short distance ahead of the welding zone.
- The wire feed mechanism begins to feed the welding wire into the joint at a controlled rate
- An electric arc is established as the

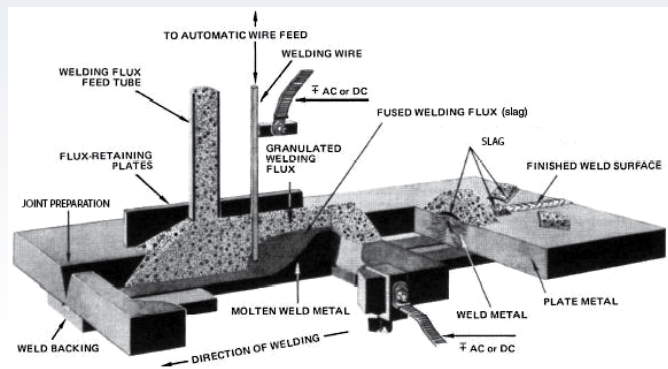

current flows between the electrode and the work.

- The carriage is started (manually or automatically) to travel along the seam.

The tremendous heat evolved by the passage of the electric current through the welding zone melts the end of the wire and the adjacent edges of the work-pieces, creating a pool of molten metal. The submerged arc welding flux completely shields the welding zone from contact with the atmosphere.

As the welding zone moves along the joint, the fused submerged arc welding flux cools and hardens into a brittle, glass-like material which protects the weld until cool, then usually detaches itself completely from the weld.

Benefits

- High quality
- Little risk of undercut and porosity
- No spatter
- Very little risk of lack of fusion due to deep and safe penetration
- High deposition rate
- High thermal efficiency
- No radiation (since no open arc)
- No need for fume extraction

Limitations

- Precise joint preparation required

- PA and PB (PC) position only
- No observation of arc and process during welding possible
- High operational effort

Equipment – Basic Principles

The high welding speeds and deposition rates which are characteristic of submerged arc welding require automatic control of the motor that feeds the welding wire into the weld. No manual welder could smoothly deposit welding wire at speeds comparable to those of a submerged arc welding machine. Nor could he maintain the same precise control of welding parameters. The automatic control and power supply system used in submerged arc welding operates to maintain a constant voltage and current.

Relationship of welding voltage to distance between welding wire and work-piece

The welding voltage is proportional to the length of the current path between the welding wire and work-piece:

- If the distance between wire and work-piece increases, the welding voltage will increase.
- If the distance between the wire and work-piece decreases, the welding voltage will decrease.

- If the distance between wire and work-piece remains constant, the welding voltage will remain constant.

Rate of wire melt-off vs. rate of wire feed

- **Constant current power**
If, for any short period of time, the current flowing through the welding zone melts off the wire at a faster rate than it is being fed, the distance between wire and work will increase, and welding voltage will increase. Conversely, if for any short period of time, wire is fed faster than it melts off, the distance between wire and work will decrease, and welding voltage will decrease.
A constant welding voltage can be maintained if a control unit is used which will automatically vary the rate of wire feed with change in welding voltage.
- **Constant voltage power**
With a constant potential power system the arc voltage is maintained by the power supply. Arc current is controlled by the wire feed speed with increased wire feed producing increased current. Therefore, the wire feed system is simplified to a constant

speed device and arc control is performed by the power source.

Controllable variables

A knowledge and control of the variables in submerged arc welding are essential if welds of good quality are to be consistently obtained. The variables are:

1. Welding current

Welding current is the most influential variable. It controls the rate at which welding wire is burned off, the depth of fusion, and the amount of base metal fused. If the current is too high, the depth of fusion will be too great and the weld may melt through the backing. In addition to this, the higher heat developed may excessively extend the heat-affected zone of the adjacent plate. Too high a current also means a waste of power and a waste of welding wire in the form of excessive reinforcement. If the current is too low, there is insufficient penetration and not enough reinforcement.

2. Welding voltage

This is the potential difference between the tip of the welding wire and the surface of the molten weld metal. The

welding voltage varies with the length of the gap between the welding wire and the molten weld metal. If the gap increases, the welding voltage increases; if the gap decreases, the welding voltage decreases.

The welding voltage has little effect on the amount of welding wire deposited; mainly the welding current determines this. The voltage principally determines the shape of the fusion zone and reinforcement. High welding voltage produces a wider, flatter, less deeply penetrated weld than low welding voltage.

3. Welding speed

With any combination of welding current and voltage, the effects of changing the welding speed conform to a general pattern:

- If the welding speed is increased:**
- Power or heat input per unit length of weld is decreased.
 - The deposited weld bead becomes smaller.
 - Penetration decreases.
 - If speed is too high there is more risk of undercut and insufficient reinforcement.

If the welding speed is decreased:

- Power or heat input per length of weld is increased.
- The deposited weld bead becomes larger.
- Penetration increases.

Consequently a large weld bead can lead to a slow cooling rate and excessive grain growth, which can have a deleterious effect on the toughness of the weld metal.

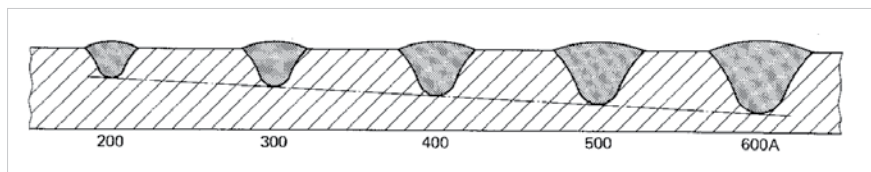

Effect of welding current on weld profile.

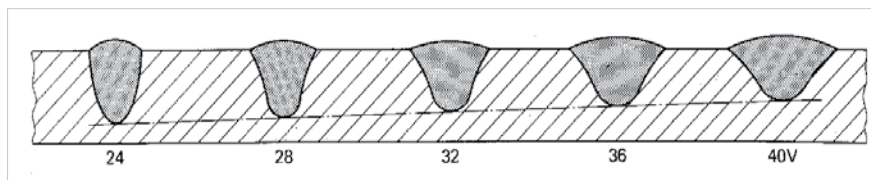

Effect of arc voltage on weld profile.

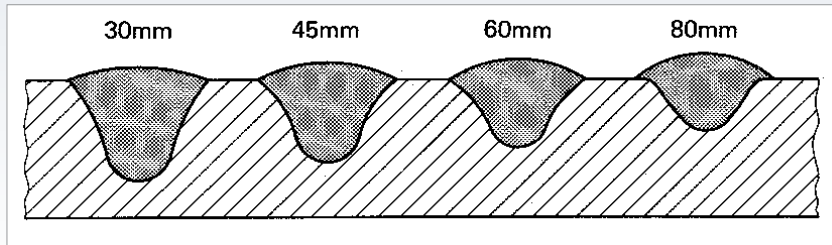

Effect of wire extension on weld profile.

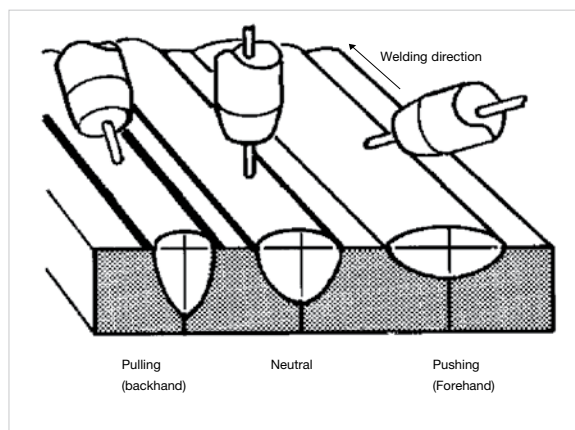

Circumferential welding

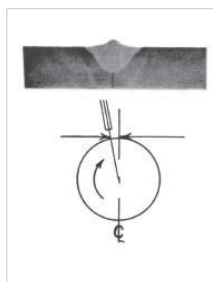

Small offset

- Low amount of metal at edges
- High peak at centre
- Deep penetration

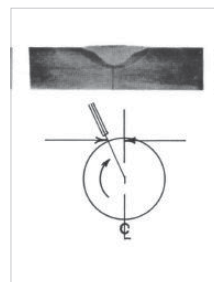

Desired offset

- Medium.
- Level weld with slight reinforcement

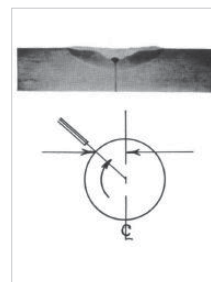

Large offset

- Flat shallow weld
- Reinforcement low at centre and high at edges

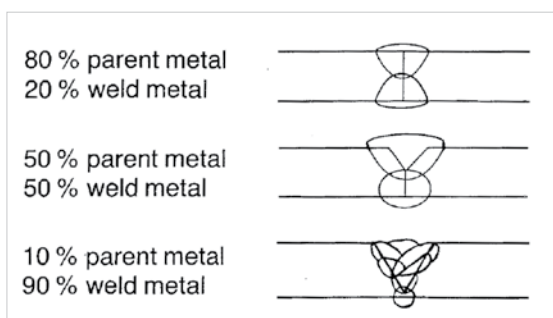

Weld metal dilution depends on the joint preparation.

If the welding speed is decreased beyond a certain point, the penetration will also decrease. This is because a good portion of the molten weld pool will be beneath the welding wire and the pool will cushion the penetrating force of the arc.

4. Width and depth of welding flux

If the granular layer is too deep, a rough weld is likely to result. The gases generated during welding cannot readily escape, and the surface of the molten weld metal is irregularly distorted.

If the granular layer is too shallow, the welding zone will not be entirely submerged. Flashing and spattering will be present; the weld will have a bad appearance, and may be porous. An optimum depth of granular material exists for any set of welding conditions. This depth can be established by slowly increasing the granular material until the welding action is submerged and flashing no longer occurs.

5. Electrode extension

The distance between the contact tip and work-piece is normally referred to as electrode extension or stick-out and is typically between 20 – 40mm. Deposition rates can be increased with the use of longer extensions due to resistive heating of the wire. If the stick-out is too long then the wire is preheated and can tend to wander leading to miss-alignment also penetration is reduced.

6. Angle of welding head

The pulling or backhand technique gives greater penetration and a narrower weld with a more convex weld bead. There is increased risk of undercut using this technique. Conversely pushing or forehand will give less penetration, a less convex weld bead and a low risk of undercut.

SAW variants

Cored Wire



The use of cored wire is a very simple and easy way to increase the deposition rate in SAW without any major changes to existing equipment. As the current density determines the burn-off rate of the wire, the deposition rate with the cored wire is higher than that with solid wire. The powder in the core of the wire can be used to achieve weld metal chemistry and mechanical properties that may not be readily available with solid wires.

Cored wires can be used in any of the process variants listed here to give extra productivity benefits.

Single Wire

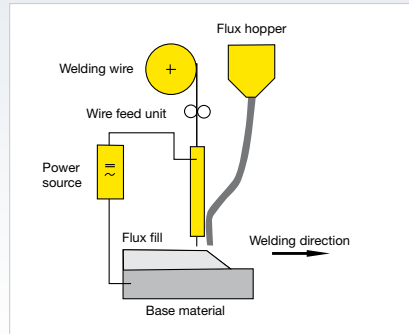

Single wire welding is the most widely used SAW method. The solid or cored wires are typically 2.0 – 4.0mm diameter, although for some thin plate, high speed applications 1.2 – 1.6mm can be used. DC+ current is generally used with 20–40mm stick-out. A smaller diameter produces a higher deposition rate at the same current, because of a higher current density. The current range for a larger diameter involves higher currents and therefore also higher deposition rates. A smaller diameter wire produces a more deeply penetrating and narrower weld bead.

Twin Wire

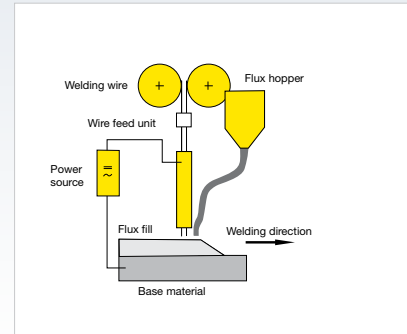

For twin-wire welding, two wires are connected to the same power source. A standard SAW machine is equipped with double drive rolls and contact tips suitable for feeding two wires through the same contact nozzle simultaneously. It produces considerably higher deposition rates than the conventional single-wire process using large diameter wires. It offers up to 30% higher deposition rates and can be used at higher currents and speeds. Very high welding speeds can be achieved in fillet welding, but is also used successfully for butt welding. Cored wires can further enhance deposition rates.

Number of Wires	1	2	
Number of Power Sources	1	1	
Wire Diameter Range (mm)	1.6 - 5.0	1.2 - 3.0	
Current Range (A) total	200 - 1000	400 - 1200	
Current Type	DC+	DC+	
Voltage (V) per wire	25 - 38	26 - 38	
Max. total deposition rate solid wire (kg/h)	up to 12	up to 15	

Tandem

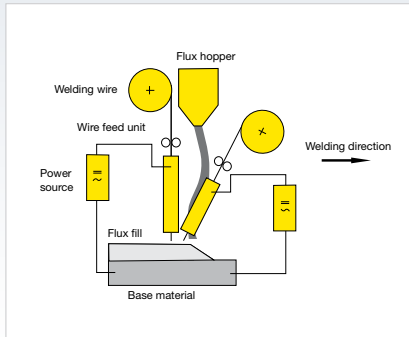

In tandem sub-arc welding each of the two wires is connected to its own power source and fed simultaneously by its own feed unit. The lead arc, operating at high current (mostly DC+) and low voltage, gives deep penetration, whilst the trailing arc usually uses lower current (mostly AC to avoid arc blow) to smooth and finish the weld bead. The wires are normally large diameter (3.0-5.0 mm) and deposition rates are about twice that of single-wire welding. The additional capital expenditure is quite high. It is widely used in shipbuilding, offshore, beam production, wind tower production and pipe mills.

Tandem Twin

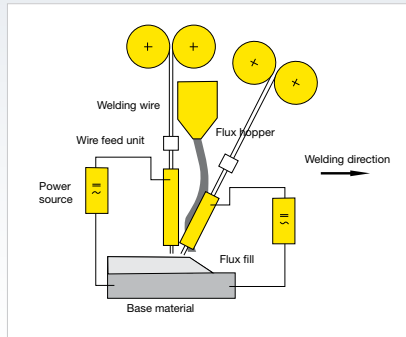

The ESAB tandem-twin process involves two twin wire heads placed in sequence. With the use of 4 x 2.5mm diameter, wires deposition rates of up to 38 kg/h can be achieved. The process can be used in joints that allows accessibility for the equipment, e.g. circumferential welding in wind tower fabrication.

Multi Wire

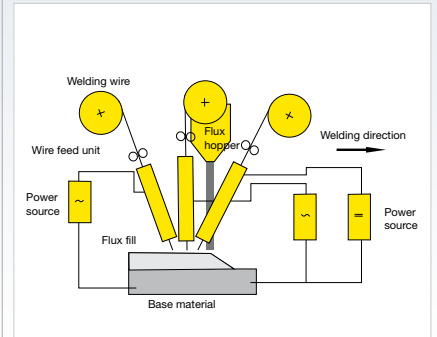

Up to five wires can be used together, each with their own power source. The lead wire is usually DC+ polarity with the trailing wires being AC. Speeds of up to 2.5 m/min can be achieved giving a maximum deposition rate of 90 kg/h. This technique is particularly suitable for longitudinal pipe welding.

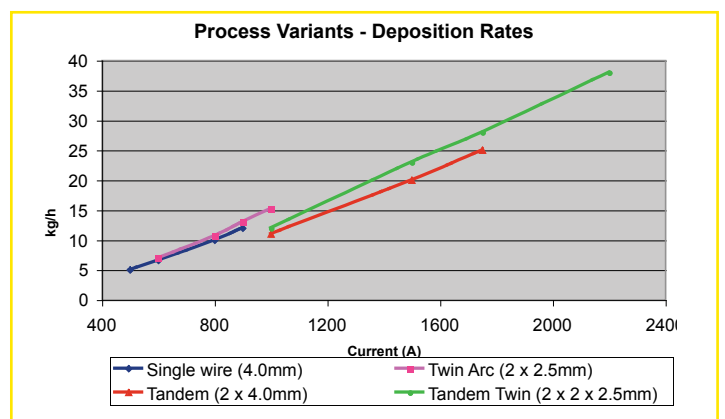

2	4	3 - 6
2	2	3 - 6
3.0 - 5.0	2.5 - 3.0	3.0 - 5.0
1500 - 2400	1500 - 2200	2000 - 5500
DC+, AC	DC+, AC	DC+, AC, AC
28 - 38	26 - 38	30 - 42
up to 25	up to 38	up to 90

ICE™ technology - Integrated Cold Electrode

ICE™ exploits the excess heat generated by the welding process to melt an additional non-powered welding electrode – the Integrated Cold Electrode. This yields significant productivity benefits as increased deposition rate without increasing heat input. The process is very easy to set; there is only one additional parameter, the cold wire feed speed. The cold wire feed speed is controlled as a percentage ratio of the hot wire feed speed (cwfr).

This technology is suitable for all industries that are looking to increase deposition rates, increase welding speed, lower total heat input and distortion, and reduce flux and energy consumption. Experience has shown that welding productivity has more than doubled using

ICE™ and reducing operational cost at the same time. In many applications throughput has more than doubled.

ICE™ is often used in two setups, a single ICE™ torch or a tandem setup with a single wire leading and the ICE™ torch trailing. The ICE™ Process is controlled by the PEK controller while set up with an ESAB power source. This technology can be used with LAF, TAF and the Aristo® 1000 AC/DC. Using ICE™ together with the Aristo® 1000 AC/DC boosts productivity even more by the True Square Wave Technology using Balance and Offset settings in AC.

The ICE™ technology can be used in narrow joint types with excellent results. In the tandem set-up the lead is often DC+ or AC and ICE™ on AC.



ICE™ 3x2.5 mm



Tandem Single wire
+ ICE™ 3x2.5 mm



Up to 50% higher
deposition rate

ICE™ 3x2,5 mm

No. of power sources	1 - 2
Amperage	450 - 1500 A
Cold wire feed ratio (cwfr)	10 - 100 %
Voltage	30 - 40 V
Welding speed max:	1700 mm/min
Polarity	DC+, AC, Unbalanced AC
Process modes	CA, CW(CV), CC
Deposition rate max*	42 kg/h

The single torch set-up is suitable for applications where heat input should be kept on a very low level. Typical applications are fillet welds for beams, one side welding of thinner plates and wire cladding.

The ICE™ technology not only gives higher productivity but also less distortion which in certain applications dramatically reduces the post-work time.

*deposition rate depending on application

Tandem Single 4 mm + ICE™ 3x2,5 mm

No. of power sources	2 - 4
Amperage:	900 - 3000 A
Cold wire feed ratio (cwfr)	10 - 100 %
Voltage:	30 - 40 V
Welding speed max	1900 mm/min
Polarity	DC+, AC, Unbalanced AC
Process modes:	CA, CW(CV), CC
Deposition rate max*	62 kg/h

Using the ICE™ technology in a tandem setup as a trailing torch provides a flexible solution with the benefits of a single wire and a high deposition rate of the ICE™. The single wire in front secures a high penetration while the ICE™ head gives the increased deposition rate, especially suitable for industries where high deposition rates are desired. Tandem with ICE™ is very easy to set up compared to other high deposition multi wire solutions as it contains only two welding torches.

Cored wires for submerged arc welding

Cored wires can replace solid wires in the submerged arc welding process to give an immediate productivity benefit, without any major capital expenditure.

With cored wires the current is carried only by the steel sheath. This leads to an increase in the current density and subsequently a higher wire burn-off rate. This increased burn-off can result in 20-30% more weld metal being deposited, compared with the same diameter solid wire at the same current.

An increased deposition rate leads to productivity benefits, reducing costs with less flux consumption, less energy consumption and reduced labour costs.

There are two variants of cored wires used in the submerged arc process. These are:

Metal cored recommended for fillet welding

OK Tubrod Wire	Alloy
14.00S	CMn
14.02S	0.5Mo
14.07S	1Cr 0.5Mo

Basic recommended for butt welding

OK Tubrod Wire	Alloy
15.00S	CMn
15.21TS	0.5Cr 0.5Mo
15.24S	1Ni
15.25S	2Ni
15.27S	2.5Ni 0.3Mo

A further benefit is the excellent mechanical properties, even at high heat inputs, achieved through the use of deoxidants in the core of the wire.

Controlled higher heat inputs can further improve the productivity of the submerged arc welding process.

The depth of penetration per amp with a cored wire will always be lower than that achieved with a solid wire. This needs to be considered when establishing suitable parameters for the root area of joints and also for square edge butt joints.

Cored wires will produce a more favourable, rounded bead shape than solid wires which reduces the susceptibility to cracking by reducing the depth / width ratio. Also in two-sided, two pass welds there is less chance of misalignment.



Solid wire



Cored wire

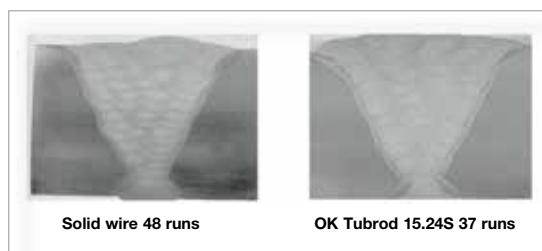

Increased deposition on 50mm plate
Productivity increase of 30%

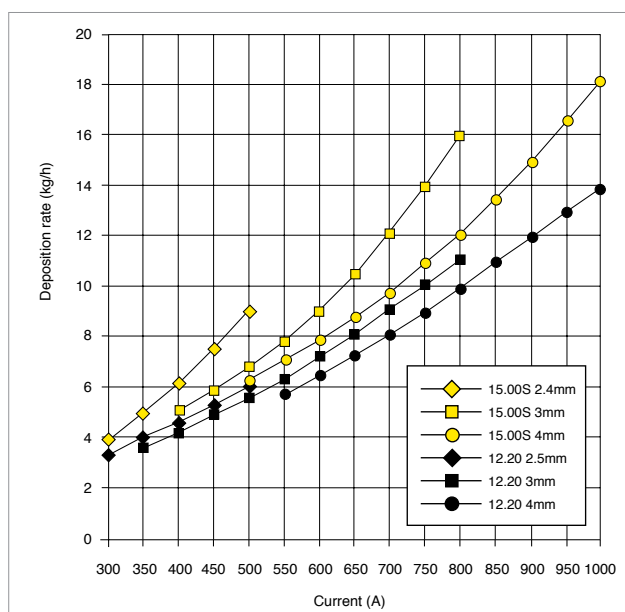

Deposition rate comparison OK Tubrod 15.00S and OK Autrod 12.20 / OK Flux 10.71.

Automation

Welding automation gives distinctive advantages, such as high quality, higher capacity and of course much higher productivity.

ESAB develops and manufactures a wide range of mechanised and automated welding solutions to meet any need.

Rely on ESAB for a total system responsibility. The experienced automation team co-operates with the customer to ensure a complete solution, including process optimisation, testing and training.



Welding heads

- MiniMaster: (low weight welding - compact, flexible)
- ArcMaster: (heavy weight welding - flexible, reliable, durable)
- Tandem Master
- Tandem Twin
- Compact 300/500/700



Wire feed units

The ESAB A2 SAW wire feed unit is designed for small wire submerged-arc welding and can be used for single or twin-wire welding.

The A6 SAW wire feed unit is designed for heavy-duty welding. Single or twin wire, strip cladding or arc-air gouging.



Carriers

- Tractors
- Column and boom
- Telbo™, telescopic boom
- MechTrac
- Beam travelling carriage
- AGW tank welder



A2 Multitrac



A comprehensive range of welding column and booms are available for different customer requirements and applications, with loading capacities and working ranges for utmost accessibility to the welding joints.

Controllers

- A2-A6 Process Controller PEK
- A2 Process Controller PEI

PEK



Power sources

- Aristo® 1000 AC/DC SAW: an AC/DC inverter power source for efficient submerged arc welding, designed to be used with digital PEK controller and the robust A2/A6 feeder units.
- LAF: a range of DC SAW robust power sources from 630 to 1600 A with well documented welding properties.
- TAF: a family of AC SAW power sources comprising sizes 800 and 1250 A with square wave output to avoid arc blow

Aristo® 1000



Flux handling

- OPC: (recovery system for heavy duty environments)
- FFRS Basic & Super: (recirculated systems for continuous welding)
- FFRS 1200 & 3000: (long runs & mass production)
- CRE 30/60 Air drying unit: (built in monitor system, reduce condensation)



ESAB has different flux equipment/systems to combine with automatic submerged-arc welding equipment. The OPC flux recovery units have a robust, compact design – easy to fit and easy to use. They can be fitted equally well to A2 and A6 equipment, both stationary and travelling. The FFRS-systems (flux feed and recovery) are designed for continuous, high-capacity welding operations. They are ideal for long runs and mass production.

Handling

- Positioners
- Roller beds

ESAB has a comprehensive range of positioners for automatic welding. These very versatile handling tools enable welding to be carried out in the optimum positions to enhance productivity and quality. They are easily integrated with A2/A6 automatic welding equipment.

ESAB offers a wide range of roller beds – conventional roller beds with mechanical adjustment for circular workpieces and self-aligning roller beds which automatically adapt to the workpiece diameter. These roller beds are designed to operate in combination with A2/A6 automatic welding equipment and ESAB column and booms.



Fluxes

The main task of SAW fluxes is to protect the arc, the molten pool and the solidifying weld metal from the atmosphere.

Moreover fluxes have the following tasks:

- **Creation of ions to increase arc conductivity**
- **Arc stabilizing**
- **Creation of a slag which forms a cavity**
- **Influence weld bead shape and surface finish**
- **Deoxidation of the molten pool**
- **Alloying the weld metal with various elements (most fluxes)**
- **Influence the weld cooling rate**



Agglomerated flux

Fluxes consist of minerals such as quartz, limestone, bauxite, fluorspar, manganese and aluminum oxides. These components are obtained from natural sources, globally. All raw materials are well defined and specified. The ESAB welding fluxes are composed according to centrally controlled formulations.

Fluxes can be grouped according to their method of manufacture; there are fused, agglomerated and mixed types. Fused fluxes are produced by melting all ingredients in a furnace followed by crushing and granulating. The number of applications using fused fluxes is on the decline due to the fact that new steel type toughness demands cannot always be met with fused fluxes. Also it is very difficult to produce fused fluxes in an environmentally friendly manner. Mixed fluxes cover all fluxes which after fusing or agglomerating are mixed with one or more additional components or fluxes.

Agglomerated fluxes are manufactured by “rolling” the components with addition of silicates. For this, the raw materials are milled to small particles. Many of these small particles form a grain which contains the correct proportion of each component. Then the grains are dried and baked at temperatures between 600°C and 850°C. Agglomerated grains are chemically heterogeneous.

Since these fluxes have not reacted during manufacturing process metallic deoxidants or alloying elements can be added. This is one of the major advantages over fused fluxes, because the weld metal is more efficiently deoxidized. As a result the toughness values achieved at sub-zero-temperatures are higher than those from fused fluxes. During welding the flux consumption is lower, because the density is lower.

Also in many applications the bead shape with agglomerated fluxes is more favorable.

Agglomerated fluxes are designed for a wide range of applications. Also in countries where, historically, fused fluxes have been used, more and more customers are transferring to agglomerated fluxes. Since these fluxes are hygroscopic, it is recommended to either re-dry the flux, prior to use, for hydrogen sensitive applications or to purchase them in moisture resistant packages such as BlockPac™ (see page 83).

Fluxes are supplied usually with a particle size range of between 0,2 and 2,0 mm, for special applications also with finer or coarser grains. There are no AWS rules governing fluxes alone but they are covered by the international standard EN ISO 14174 (see page 86). The chemical composition of the flux has a major influence on its basicity and thus on expected toughness levels (for optimal flux selection: See page 16). In the welding process reactions take place between the melting wire electrode and the flux, chemical elements can be alloyed or burnt out. For major elements this metallurgical behaviour is specified in the standard. Furthermore, broad application groups, type of current and hydrogen classes are specified in order to get a quick overview over the characteristics of a given flux.

Neutral, active or alloying fluxes

Fluxes for submerged arc welding can be grouped into neutral, active and alloying fluxes. Many fluxes alloy some Si and Mn to the weld metal; yet others burn off these elements. The intensity of this chemical reaction depends on the flux quantity interacting with the wire. An increase in voltage/arc length will lead to an increased alloy or burn-off of elements.

Neutral fluxes

In the ESAB product range, neutral fluxes are those intended for multi-layer welding of unlimited plate thickness with appropriate wires. The alloying of elements, especially Si and Mn, are carefully controlled. After the balance for each element is met, the level remains consistent throughout all following runs.

The all weld metal chemical analysis indicates the balance point and is a good reference. For single layer applications with neutral fluxes, the use of wires with higher Si and Mn contents may be considered.

Active fluxes

Active fluxes add a significant amount of Si, acting as a deoxidiser, and Mn to the weld metal. They enhance resistance to porosity, improve bead appearance and toughness in high dilution applications. Active fluxes are primarily used for single pass or multi-layer welding with limitation of layers.

Since the balance point for Si and Mn is above normally anticipated levels, 3 - 5 layers is normally the maximum.

Alloy fluxes

Alloy fluxes create an alloyed weld metal, when combined with unalloyed wires. The ESAB product range offers a number of alloyed fluxes used for cladding applications. These fluxes add C and Cr as well as Si and Mn to the weld metal. The alloying of elements is related to the arc voltage, since this has an influence on the amount of flux being melted and taking part in the chemical reaction. In order to create a specific weld metal composition, the arc voltage must be carefully controlled.

ESAB Submerged arc joining fluxes

Each joining flux is categorised as neutral or active in the table on page 13.

Weld metal alloying

In the arc, chemical reactions take place between the molten wire and the molten flux. They depend on the composition of both consumables.

Worldwide

Wires with relatively low Mn and moderate Si content are widely used. Most common is EM12K (OK Autrod 12.22) with typically 1.0% Mn and 0.2% Si. Most fluxes alloy some Mn and Si to the weld metal to obtain the desired Mn content of about 1.0 – 1.5% Mn and a Mn/Si ratio of at least 2.

In non-alloyed weld metals, Mn is the main element used to increase the strength. Si is needed for deoxidation and fluidity of the molten pool. C is burnt-off

by the fluxes. A low C content is desired for good toughness values.

Only high basic fluxes (e.g. OK Flux 10.62) are neutral with regard to Si and Mn. All alloying comes from the wire, making the chemical weld metal composition largely independent of the number of passes and welding parameters. High basic fluxes are generally combined with wires with increased Mn content such as OK Autrod 12.32, EH12K.

Asia Pacific

Traditionally in Asia, wires with a high Mn and low Si content are used. These are EH14 (OK Autrod 12.40) with less than 0.1% Si and

2.0% Mn. In order to produce the desired weld metal composition, appropriate fluxes burn-off Mn. They alloy high amounts of Si. A similar amount of C is burnt-off, as with European fluxes.

Suitable fluxes for multi-pass welding with OK Autrod 12.40 are OK Flux 10.61 and 10.62.

Flux-wire-combinations are a well adjusted systems. Generally, an EH14 wire is not welded with a Mn-alloying flux, particularly not for multi-pass welds, because of alloying mismatch. For special applications (high dilution), however, it can be a suitable combination.

Hydrogen in ferritic weld metal

ESAB H5 class low-hydrogen welding fluxes:

- OK Flux 10.62
- OK Flux 10.63
- OK Flux 10.64
- OK Flux 10.71
- OK Flux 10.72
- OK Flux 10.74
- OK Flux 10.77

ESAB H4 class low-hydrogen welding flux:

OK Flux 10.62
when delivered in BlockPac™

Ferritic, fine grained steels, especially those with higher or high strength ($R_{el} > 460$ MPa), are sensitive to hydrogen induced cold cracking. Cracking can occur in the heat affected zone (HAZ) and sometimes in weld metal, after cooling down below 150°C . Cracking can often be delayed several hours after welding. The risk of hydrogen induced cold cracks is governed by the 3 factors; microstructure, stress and hydrogen.

HAZ and weld microstructure

With increasing base material and weld metal strength, the sensitivity for cold cracks increases. Strength is related to hardness, which is determined by the chemical composition (CE; carbon equivalent) and the $t_{8/5}$ cooling time (see below: Preheating). In order to achieve a high strength in steel and weld metal, alloying elements are intentionally added. This increases the CE value and sensitivity for cold cracking.

Stresses

During welding, thermal stresses are added to the joint due to non-uniform temperature distribution. In thicker plates using multi-layer welding, these stresses increase which means a greater risk of cold cracks. An unfavorable design of a construction or an unfavorable order of completing welding joints can further increase stresses.

Hydrogen

Hydrogen can be introduced into weld metal from many different sources, such as the surrounding atmosphere, plate contamination (cutting oil, grease, dirt, paint, coating, rust), flux and wire and compressed air. All factors must be carefully controlled. For welding high strength steels, fluxes with

the supplement H5 (or H4) according to EN ISO 14174 should be used. This means that a weld metal with maximum 5 ml hydrogen per 100 g weld metal is produced with re-dried flux. An increasing hydrogen level increases the risk of cold cracks. Re-drying of the flux prior to use is recommended unless delivered in BlockPac (see page 83).

Preheating

High strength steels should be preheated before welding, including tack welding. Preheating increases the time the welding zone remains above 150°C ; temperatures at which hydrogen can diffuse away. It also reduces stress and eliminates moisture from the plate surface. Preheat temperatures are usually between 80°C and 150°C . The heat input and maximum interpass temperature must be well controlled for good toughness. A desired, fine grained structure is achieved by using multi-layer techniques with thin layers. An immediate post heating (soaking; $200^{\circ}\text{C} - 300^{\circ}\text{C}$ / for at least 2 hours) further reduces the hydrogen in the welding zone (see: EN1011-2).

Austenitic weld metals are not sensitive to hydrogen cold cracking, because their face centered cubic lattice can dissolve a substantially higher amount of hydrogen.

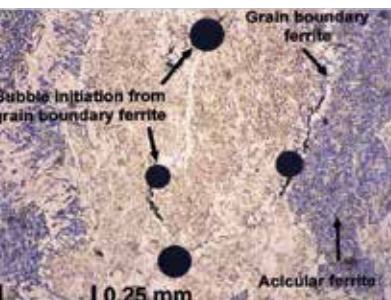

Hydrogen bubble initiation and propagation from α grain boundary

Global manufacturing

OK Flux is an ESAB AB trademark and consequently the OK Flux range is fully globally managed, together with OK Autrod and OK Tubrod solid and cored SAW wires.

All ESAB plants manufacturing OK Flux products do so based on centrally submitted specifications in terms of:

- Raw materials
- Testing methods
- Product release inspection
- Manufacturing process, process parameters and limits
- Product packaging and marking requirements
- Product 3rd party international approvals
- Product Lifecycle Management (PLM)
- Quality Management System
- ISO 14001
- OHSAS 18001

With all these measures in place, ESAB is confident that OK products have identical properties regardless of manufacturing location, worldwide.

Several OK products are made in more than one location to meet local geographical demands. Equally important, this is part of ESAB's supply contingency plan, a global effort to consistently meet the supply chain needs of our customers.

It is with this in mind that ESAB is able to supply a market from different factories, in order to provide the best possible delivery service.



Production facility certificates



R&D and Central Laboratory

ESAB Central Laboratories

The ESAB Central laboratories in Gothenburg, Sweden, together with the Process Centre, form the technical heart of ESAB worldwide. Equipped with modern facilities, they provide research services to the development departments, to production sites and to end customers.

The several laboratories are:

- Metallographic laboratory
- Mechanical testing
- Chemical laboratory
- Welding laboratory
- Heat treatment laboratory

Principal activities are:

- Customer support:
Defects, properties, welding procedures, failure analysis.
- Development support:
Microstructure and properties for development and improvement of products.
- Research:
Internal and external (universities, institutes) research projects.
- Production support:
Verification of product quality and production processes.



Welding Process Centres

The central ESAB Welding Process Centre, located in Gothenburg, Sweden, is a fully equipped, multifaceted training and development facility – specifically designed for advanced process and welding application support to customers. The Process Centre is equipped with a great variety of arc welding processes, including (multi-wire) SAW. In addition to this, the Process Centre has a well-equipped training area for all types of manual welding, complete with several individualised training booths for learning and practicing all types of manual welding, such as MMA, TIG and MIG/MAG. Additional process centres are located around the world in places such as Singapore and Dubai.

We work in cooperation with our customers to explore the best welding process variants. Our process centres hold the expert knowledge about our filler metals and equipment to ensure that our customers get the maximum benefit from them.

Our focus is to help our clients become more competitive by optimising the quality and efficiency of their welding applications and processes – for best possible welding economy – through application research, expert advice and training.











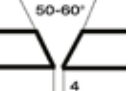

SAW joint preparations

Typical welding data and recommended joint preparations for submerged arc welding.

Non and low-alloyed steels

Type of joint	Plate thickness mm	Wire diameter mm	Run no.	Welding current A	Arc voltage V	Welding speed cm/min	
	6	3.0	1	320	32	80	
		3.0	2	350	32		
	8	4.0	1	450	32	75	
		4.0	2	500	32		
	10	4.0	1	550	33	70	
		4.0	2	600	33		
	12	4.0	1	600	33	60	
		4.0	2	650	33		
	14	4.0	1	700	34	55	
		4.0	2	750	34		
 Gap: as small as possible; in locations where gap > 1 mm: MMA or MAG root run.	For all procedures: 1 run from back side:						
		4.0	1	680	32	50	
	14	4.0	1	650	26	50	
	16	4.0	1	580	26	60	
		4.0	2	750	34	60	
	18	4.0	1	580	26	60	
		4.0	2	750	34	50	
	20	4.0	1	580	26	60	
		4.0	2	750	30	60	
		4.0	3	750	34	60	
	25	4.0	1	580	26	60	
		4.0	2	750	30	60	
		4.0	3	750	30	60	
		4.0	4 - 5	750	32	50	
	30	4.0	1	580	26	60	
		4.0	2	750	30	60	
		4.0	3	750	30	60	
		4.0	4 - 5	750	32	50	
		4.0	6 - 8	750	32	50	
	≥ 40	4.0	1	580	26	60	
		4.0	2	750	30	60	
		4.0	3	750	30	60	
		4.0	4 - 5	750	32	50	
		4.0	6 - n	750	32	50	
	Alternative parameters for first run (all thicknesses):						
		4.0	1	450	25	45	
	 Welded from 1 side root run: MMA or MAG. Thickness of root run ≥ 5 mm.	14		1	MAG or MMA		
			4.0	2	550	26	50
		4.0	3	600	30	50	
		4.0	4	680	32	50	
16			1	MAG or MMA			
		4.0	2	550	26	50	
		4.0	3	650	32	50	
		4.0	4 - 5	680	32	50	
18			1	MAG or MMA			
		4.0	2	550	26	50	
		4.0	3 - 4	650	30	50	
		4.0	5 - 6	680	32	50	
20			1	MAG or MMA			
		4.0	2	550	26	50	
		4.0	3 - 4	650	30	50	
		4.0	5 - 6	750	32	50	
		4.0	7	680	32	50	
22			1	MAG or MMA			
		4.0	2	550	26	50	
		4.0	3 - 4	650	30	50	
		4.0	5 - n-2	750	32	50	
		4.0	n-1 - n	680	32	50	

Type of joint	Throat thickness mm	Wire diameter mm	Run no.	Welding current A	Arc voltage V	Welding speed cm/min
	3	1 x 3.0	1	500	28	80
	4	1 x 3.0	1	500	28	60
	5	1 x 4.0	1	650	30	60
	7	1 x 3.0	1	500	29	50
		1 x 3.0	2	620	32	60
	4	1 x 3.0	1	600	32	100
	5	1 x 3.0	1	600	32	60
	6	1 x 3.0	1	650	32	55
	7	1 x 3.0	1	750	32	45
	Twin Arc					
	4	2 x 1.6	1	750	32	115
	5	2 x 2.0	1	800	32	100
	Cored wire					
	5	2 x 2.4	1	800	30	120
	Tandem DC+, AC					
	4	4.0	1 (DC+)	800	32	140
		4.0	1 (AC)	700	36	
	Tandem DC+, AC					
	4	4.0	1 (DC+)	800	32	140
		4.0	1 (AC)	700	36	
	5	4.0	1 (DC+)	800	32	90
	4.0	1 (AC)	700	36		

Note: If a cored wire is used, an extra 2 volts are required in the high current range (>600A) to spread the extra weld metal (25-30%).

Stainless steels

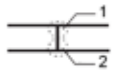
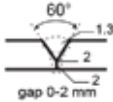
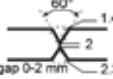
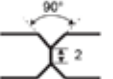
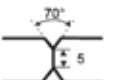
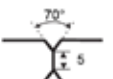
Type of joint	Plate thickness mm	Wire diameter mm	Run no.	Welding current A	Arc voltage V	Welding speed cm/min
	6	2.4	1	300	33	40
		2.4	2	400	34	40
		3.2	1	400	34	100
		3.2	2	500	34	130
	8	2.4	1	350	33	40
		2.4	2	450	34	40
		3.2	1	450	34	55
		3.2	2	550	34	55
	4	1	450	34	100	
	4	2	550	34	130	
	10	2.4	1	420	30	45
		2.4	2	420	32	40
		2.4	3	420	32	40
		3.2	1	500	30	55
		3.2	2	500	32	55
		4	1	550	31	65
		4	2	550	34	100
	12	4	1	600	32	60
		4	2	600	34	80
	20	4	1	575	31	60
		4	2	600	32	60
		4	3-5	600	34	65
	25	4	1	550	32	60
		4	2	600	34	50
		4	3	600	34	50
		4	4-8	600	34	60
	6	2	1-n	300	31	60
	10	3.2	1-n	380	32	65
	16	3.2	1-n	450	34	70
	8	4	1	450	32	90
		4	2	550	34	85
	10	4	1	500	32	65
		4	2	600	34	85
	12	4	1	500	32	60
		4	2	600	34	70
	14	4	1	550	32	60
		4	2	600	34	60

Trouble shooting guide

Defect	Possible causes	Remedies
Arc extinguished	Wire feed problem	Check wire feed pressure and ensure smooth wire feeding
Arc instability	Poor earth	Check earth connections
	Leads frayed	Check if leads are over heated
	Presence of large steel mass	Use AC current
	Deep groove	Reduce voltage / wire extension
	Earthing too distant	Move earth closer
Erratic arc	Arc blow	Weld towards earth clamp or split earth and attach at ends
	Wire feed problem	Check wire feed pressure and ensure smooth wire feeding
	Power source failure	Refer to power source supplier
Burn through	Current too high	Reduce current
	Poor fit-up	Adjust fit-up
	Root face too small	Increase root face
	Welding speed too low	Increase welding speed
Cold laps	Heat input too low	Adjust welding parameters
	Plate temperature low	Increase preheat / interpass temperature
	Too high travelling speed	Adjust welding parameters
Insufficient penetration	Current too low	Adjust welding parameters
	Welding speed too high	Adjust welding parameters
	Wrong joint preparation	Redesign joint
Excessive reinforcement	Welding speed too low	Increase welding speed
	Current too high	Decrease current
Loss of reinforcement	Arc blow	Weld towards earth clamp or split earth and attach at ends
	Welding speed too high	Reduce speed
	Wire feed problems	Check wire feed pressure and ensure smooth wire feeding
	Irregular tack welds	Create a consistent joint preparation including tack welds
Rough irregular bead	Excessive heat input	Adjust welding parameters
	Flux cover too high	Reduce flux height
	Voltage too high	Reduce voltage
Porosity	Rusty plate	Wire brush or grind plate
	Oily plate	Degrease or grind
	Contaminated plate	Use active flux or killed wire
	Wet plate	Preheat plate
	Primer	Remove primer
	Flux cover too shallow, arc flashes	Increase flux feeding
	Wet flux	Dry flux according to instructions on bag
	Magnetic arc blow	Weld towards earth clamp or split earth and attach at ends
	Flux becomes too fine	Add at least 1 part new flux to 3 parts of recycled flux
	Defective root run with MMA	Weld defect free root run; possibly change to MAG
Slag inclusions	Flux trapped in preparation	Adjust welding parameters
	Plate preparation angle too small	Increase preparation angle
	Insufficient penetration	Adjust welding parameters
Gas imprints (pock marks)	Not enough heat	Increase heat input
	Plate surface contamination	Clean welding area
	Flux cover too high	Reduce flux height so that weld pool is just covered by slag (without reducing the stick out)
	Too high flux pressure (especially on circumferential joints)	Add flux in front of welding wire instead of around welding wire
	Flux becomes too fine	Add at least 1 part new flux to 3 parts recycled flux
	Magnetic arc blow	Split grounding cable and connect equal long cables of same quality and diameter to beginning and end of welding joint. Use AC current.
	Improper process parameter transmittal	Check whether grounding control cable is properly connected to work piece. When control cable is connected to work table or roller beds: Check on connection to work piece. Connect to work piece direct as a test.
	Moisture	Redry flux according to instructions on bag (see page 84) Preheat base material

Defect	Possible causes	Remedies
Slag sticking	Voltage too high	Reduce voltage
	Current too high	Reduce current
	Poor weld bead profile	Adjust welding parameters
	Hot plate	Check interpass temperature
	Incorrect joint preparation	Modify joint preparation
Undercut	Arc blow	Weld towards earth clamp or split earth and attach at ends
	Welding speed too high	Adjust welding parameters
	Wire alignment incorrect	Adjust alignment
	Voltage too high	Reduce voltage
Weld metal running	Rotation of work piece too slow	Increase rotation speed
	Incorrect wire position	Adjust position
	Too high voltage/current	Decrease voltage/current
	Flux too fluid	Check flux selection
Flux dust	Excessive recycling of flux	Add at least one part of new flux to three parts of recycled flux
	Too high pressure of the recycling unit	Reduce air pressure to minimum required for flux recycling
	Faulty dust extractor	Replace / repair extractor
Longitudinal cracks	Convex reinforcement	Adjust welding parameters
	Elongated weld pool	Decrease welding speed
	Poor fit-up	Reduce root gap
	Wrong consumable selection	Refer to ESAB
	Weld depth to width ratio > 1	Adjust welding parameters
	Weld metal hydrogen	Reduce all possibilities for hydrogen occurrence
Transverse cracks	Cooling rate too high	Increase preheat / interpass temperature
	Excessive restraint	Preheat or redesign joint
	Too high heat input	Adjust welding parameters
	Wrong consumable selection	Refer to ESAB



Insufficient penetration and excessive reinforcement; also misaligned.

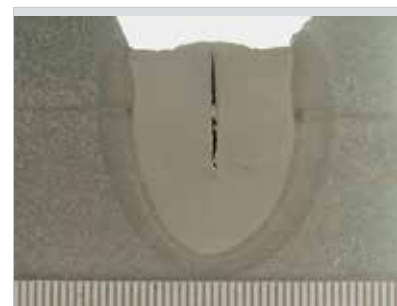

Weld depth to width ratio > 1 and relatively large amount of impurities in base material (S, P, Nb).

Do not hesitate to contact ESAB for advice in case of persistent problems or defects.

Guidelines

Recommended current ranges (single wire)

Diameter (mm)	Current (amps)
2.4, 2.5	300 - 500
3.0, 3.2	350 - 600
4.0	400 - 850

Electrode extension should be 10 times the wire diameter

Flux height should be around 30mm; the lower the better for degasing of the weld pool but there should be enough to prevent arc flashing

Handling equipment

Turntables, inner centering device and one way spider frame.

The efficiency of welding equipment can be dramatically increased by decreasing the downtime. Bulk spool types help to reduce the downtime by reducing the number of spool changes. Switching from conventional 30 kg spools to 1000 kg EcoCoil, the number of spool changes is reduced by a factor of 33.

Bulk spool types such as EcoCoil (1000 kg) and drums (280/350 kg) must be placed on turntables for decoiling. The wire is pulled by the wire feeder, which rotates the turntable. During the complete use of these spools, the wire keeps the same twist and can be straightened reliably at the welding unit.

All turntables are low friction, easy rotating and without a motor drive, because they are rotated by the pulling of the welding wire. They have an adjustable brake and are electrically isolated. This is needed, because the wire has welding voltage and any connection to ground must be strictly avoided.

The Type 1 turntable for drums has a diameter of 680 mm and a maximum load of 450 kg. The wire pick up point is integrated by a vertical wire guide stand and a low friction wire guide tube, through which the wire is fed to the welding unit. 4 plastic bolts in the turntable center the drum.

For EcoCoil there are 2 turntables. Both have a diameter of 1050 mm and a maximum load of 1000 kg. Type 2 has a wire guide stand and a fixed wire guide tube which gives the recommended 20 - 30° downwards incline to the pack which is beneficial for smooth decoiling. An inner steel centering device (yellow) designed to fit the One Way Spider Frame (blue) ensures that the packs sit in the centre of the turntable. EcoCoil is placed on the One Way Spider Frame. Type 3 turntable” is the single turntable. It has been designed for customers who position the wire pick-up point individually on their welding unit or on a steel framework.



Lifting yoke for Marathon Pac™

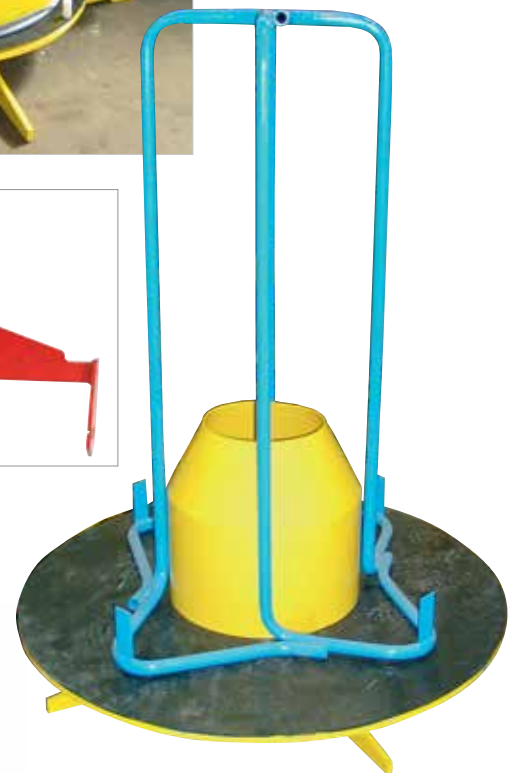

Marathon Pac™ trolley and lifting yoke

Wires up to 2.0 mm are delivered in Marathon Pac (500 kg). It is pre-twisted and feeds vertically and straight. Marathon Pac needs no rotation and thus can be placed directly on the shop floor or on a trolley available from ESAB. Marathon Pacs can be safely lifted with a CE-signed yoke approved for crane and forklift work up to 500kg.



High productivity packaging

For a welding machine to weld, the wire must be fed disturbance free to the welding head. The majority of the 25 – 30 kg packages are therefore delivered on the wire basket spool type 28 and 31. This unique Eurospool™ is not only layer wound, but it also flush-fits on a Europallet (Figure 1). Damage and thus time to fix problems are minimised. The wire end is safely secured to the spool basket by resistance welding.

Also the 100 kg package is delivered on a wire basket (Figure 2). The basket keeps the welding wire in place on the spool holder, after the transport strips are cut, securing smooth decoiling. The wire end is also fixed to the wire basket in order to prevent the end from detaching. It will, however, be detached by a reasonable strong force from the feeding motor. This is needed because 100 kg packages are often positioned at the end of the boom, away from the welding head.

In many welding set-ups, it is possible to exchange conventional 30 kg spools by bulk spool types. Spool type 33, EcoCoil with 1000 kg wire, reduces the spool changes by a factor of 33 (Figure 3). Moreover the packing material is reduced to a minimum, whilst still giving full protection from moisture and dust during transport and storage. All materials are fully recyclable. Since it is a one-way-package there is no need for any return logistics.

EcoCoil fits well on the One Way Spider frame. The costs for the required decoiling stand/turning table are soon compensated by the time saving for spool changes. Then the

cost saving begins. Advantages over heavy spools are achieved, because the wire is not spooled tightly around the cardboard core, due to a special technology (Figure 4). In the start and stop phase the spool can slowly accelerate and stop whilst the welding wire is fed to the welding head with a constant speed. Welding defects are thereby reduced.

SAW welding wires up to 2.0 mm diameter are also available in Marathon Pac (spool type 9A). The wire is pre-twisted and is fed, straight and vertically, out of the Marathon Pac. No decoiling stand is needed. Dramatic time savings on spool changes can be achieved when transferring from any low-weight spool type to Marathon Pac. All material is fully recyclable and easy to separate.

Also the selection of the most beneficial flux packaging option makes a significant contribution to manufacturing productivity increases. Please see on page 82 and 83 for different solutions for ESAB fluxes.



Spool type 9A - Marathon Pac is folded flat after use for minimal disposal space.



Figure 1. Eurospool - 30 boxes flush-fit on a europallet.



Figure 2. ESAB 100kg wire basket.



Figure 3. EcoCoil on a turning table.

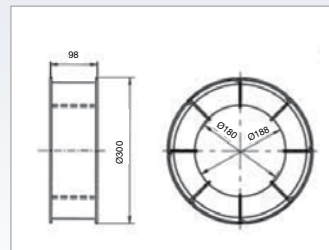
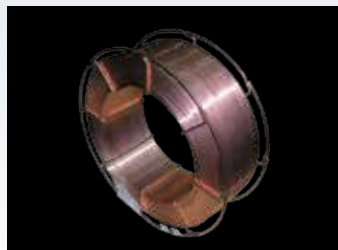

Figure 4. Spool type 33 - EcoCoil.

A suitable spool for each application

Spool type 76: 15 kg

Random wound wire basket. The empty basket is not returnable, but fully recyclable. For SAW wires up to diameter 2.5 mm.
EN ISO 544: B 300.



Spool type 08: 30 kg

Layer wound wire coil without former. Coil holder required.
EN ISO 544: C 450.

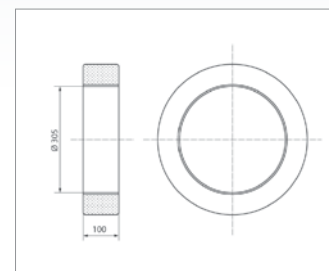

Spool type 03: 25, 30 kg

Random wound wire basket. The empty basket is not returnable, but fully recyclable.
EN ISO 544: B 450.

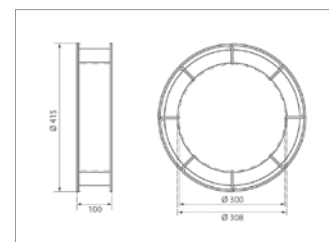

Spool type 28/31: 25, 30 kg (Eurospool)

Precision layer wound, octagonal wire basket (spool 31 is plastic coated). The empty basket is not returnable, but fully recyclable.
EN ISO 544: ~ B 450.

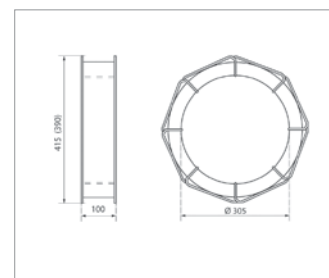
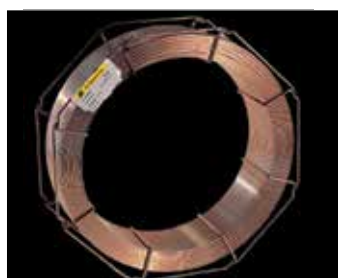

Spool type 52: 75, 100 kg

Random wound wire basket. The empty basket is not returnable, but fully recyclable. 75kg only for cored wire.

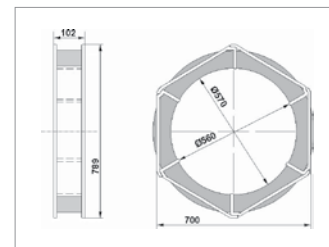

Spool type 34: 270, 300 kg

Random wound wooden bobbin. Decoiling stand needed. The empty bobbin is not returnable. 270kg only for cored wire.
EN ISO 544: S 760E.

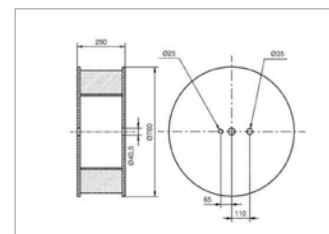

Spool type 33: 1000 kg (EcoCoil)

Random wound spool with cardboard former. 4 lifting eyelets. Decoiling stand needed. All packaging materials not returnable but fully recyclable.

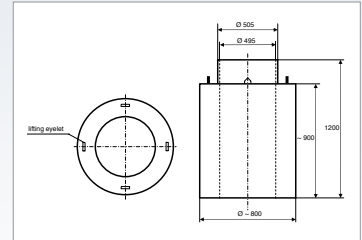

Spool type 30: 700 kg

Random wound spool with cardboard former. 4 lifting eyelets. Decoiling stand needed. All packaging material is not returnable, but fully recyclable.

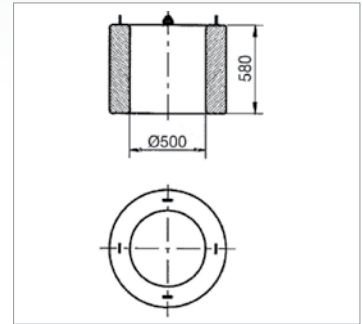
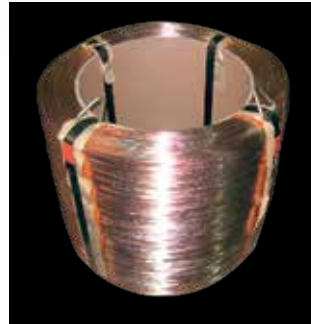

Spool type 58: 300 kg

Random wound pay-off drum. The empty drum is not returnable but can be recycled.

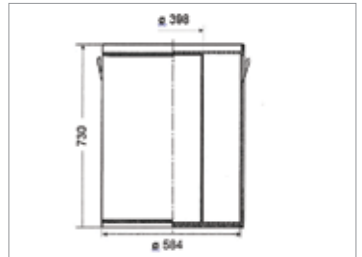

Spool type 04: 280 kg

Random wound pay-off drum. The empty drum is not returnable.

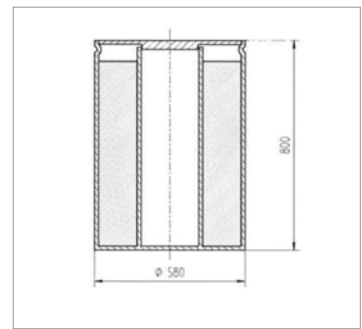

Spool type 9A: 500 kg

24-edge cardboard drum. Wire is pre-twisted for straight delivery. No decoiling stand needed. Marathon Pac 2 is not returnable, but fully recyclable. For SAW wires up to diameter 2.0mm.



Always the most productive delivery packaging



To be opened without tools



Flux flow



Re-closed BigBag

ESAB delivers fluxes in 25 kg paper bags, some types in 20 kg paper bags. Each bag has a polyethylene inlay to prevent moisture pick-up from the surrounding atmosphere. Secondary protection against moisture pick up is given by wrap foiling or shrink foiling each complete flux palette. The packing material is fully recyclable and therefore environmentally friendly. The majority of the packing material is recycled as paper.

The main ESAB flux types are also available in BigBags. Standard weight for BigBags is 1000 kg of welding flux. BigBags have a well defined discharge spout which can be closed during the flux flow.

Although it takes only about 1 minute to empty a complete BigBag, customers can choose to remove only a few kgs at a time. Therefore, BigBags are not only for large volume users. The BigBag is made from strong woven polypropylene material that has an internal multi-layered aluminium lining, keeping the flux "factory dry". Again, each palette of flux is additionally

protected by wrap foil or shrink foil primarily to protect the package just in case the package shifts in transit. The complete empty BigBag, including the aluminium liner is disposed as combustible energy recycling material, according to EN 13431.

Another advanced packing for fluxes is BlockPac™, a 25 kg moisture dense package for "Ready to use" flux (see next page).

Fluxes for stainless steels are also supplied in steel buckets containing 20 or 25 kg. The buckets are moisture tight and re-sealable. They have a sealing gasket in the lid which removes the need for flux re-drying.

ESAB specifies not only its products, but also packaging and packing materials, for all production units, globally. Hence we ensure that our customers such as international welding companies will always get the same product in the same packaging, no matter which continent their manufacturing is located.



Full protection with no moisture absorption - BlockPac™

Factory dry agglomerated welding flux for use without re-drying direct from the bag

Re-drying of fluxes prior to use is costly and time consuming for welding fabrication companies. Yet, fluxes with low moisture levels are required for many materials in order to prevent hydrogen induced cracking, especially for thick section structural steels and for all thicknesses of high strength steels.

Fluxes from 25 kg BlockPac can be used directly from the package. The laminated, multi-layer aluminium foil and the welded seal effectively protects the flux against moisture absorption from the atmosphere. Empty bags can be disposed environmentally friendly according to EN13431.

Fluxes in BlockPac have unlimited shelf life. No special warehouse storage conditions are required even in regions with severe climates. Upon opening, fresh and dry flux is guaranteed provided the bags are handled with care and the foil is not damaged.

ESAB moisture protection BlockPac has been tested extensively under tropical climate conditions. It was exposed to 45°C / 90% relative humidity for 10 weeks. In weeks 9 and 10 the dew point was artificially reached once a day and droplets appeared on the outer package. Measurements of the all weld metal confirmed low hydrogen levels meeting the H4 classification, after this severe treatment (OK Flux 10.62/OK Autrod 12.32; hydrogen testing according to EN ISO 3690).

ESAB moisture protection BlockPac offers ready to use SAW fluxes. It simplifies filler material handling procedures, saves costs and increases customers productivity in all industry segments.

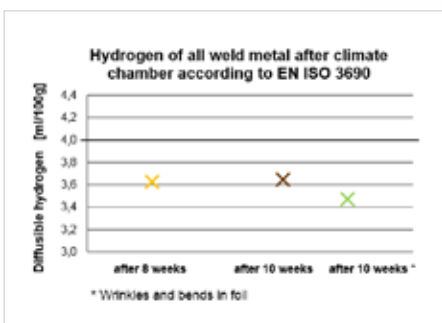

Easy and efficient storage and handling of fluxes

ESAB agglomerated fluxes have a guaranteed as-manufactured moisture content from production. This moisture content is controlled by internal ESAB specifications. Before transport, each pallet is shrunk or wrapped in plastic foil. This precautionary action is done in order to maintain the as-manufactured moisture content for as long as possible. Flux should never be exposed to wet conditions, such as rain or snow.

Storage

- Unopened flux bags must be stored in maintained storage conditions as follows: Temperature: 20 +/- 10°C
Relative humidity: As low as possible - not exceeding 60%.
- Fluxes delivered in aluminium lined 25 kg bags (BlockPac™) or BigBags can be stored under severe climatic conditions, because the packaging protects the flux reliably from moisture pick-up, as long as it is unopened and undamaged.
- Fluxes shall not be stored longer than 3 years (except BlockPac™).
- Fluxes in BlockPac™ have unlimited shelf life as long as the foil is not damaged.
- The content of unprotected flux hoppers must, after an 8 hours shift, be placed in a drying cabinet or heated flux hopper at a temperature of 150 +/- 25°C.
- Remaining flux from opened bags must be placed at a temperature of 150 +/- 25°C.

Re-cycling

- Moisture and oil must be removed from the compressed air used in the re-cycling system.
- Addition of new flux must be done with the proportion of at least one part new flux to three parts re-cycled flux.
- Foreign material, such as millscale and slag, must be removed by a suitable system, such as sieving.

Re-drying

- When handled and stored as above, the ESAB fluxes can normally be used straight away.
- In severe applications, stipulated by the applicable material specification or if the flux has somehow picked up moisture, re-drying of the flux is recommended.
- Re-drying shall be performed as follows: 300 +/- 25°C for about 2-4 hours.
- Redrying must be done either in equipment that turns the flux so that the moisture can evaporate easily or in an oven on shallow plates with a flux height not exceeding 5 cm.
- Re-dried flux, not immediately used, must be kept at 150 +/- 25°C before use.

Disposal

- Discard any product, residue, disposable container or liner in an environmentally acceptable manner, in full compliance with federal and local regulations.
- Please address your local disposal company for prescribed disposal.
- Information on product and residues are given in the Safety Data Sheets available through www.esab.com.

Equipment for storage and re-drying



JS 200 Flux storage silo

- Keeps flux dry and clean
- Adjustable temperature between 100 and 300°C
- Capacity: 200 l
- Supply voltage: 220V, 1 phase; output: 2 kW



JK 50 Powder Dryer

- Redries flux at max. 500°C for about 3 hours
- Then automatically drops temperature to pre-set value (max. 200°C) and stores flux
- Capacity: 50 l
- Supply voltage: 400V, 3 phase; output: 3.7 kW

**Classification Standard
and Approvals pages**



Classification Standard

EN ISO 14174: GUIDE TO THE EN ISO CODING, EN ISO 14174 FOR FLUXES
EXAMPLE: OK FLUX 10.71 - S A AB 1 67 AC H5

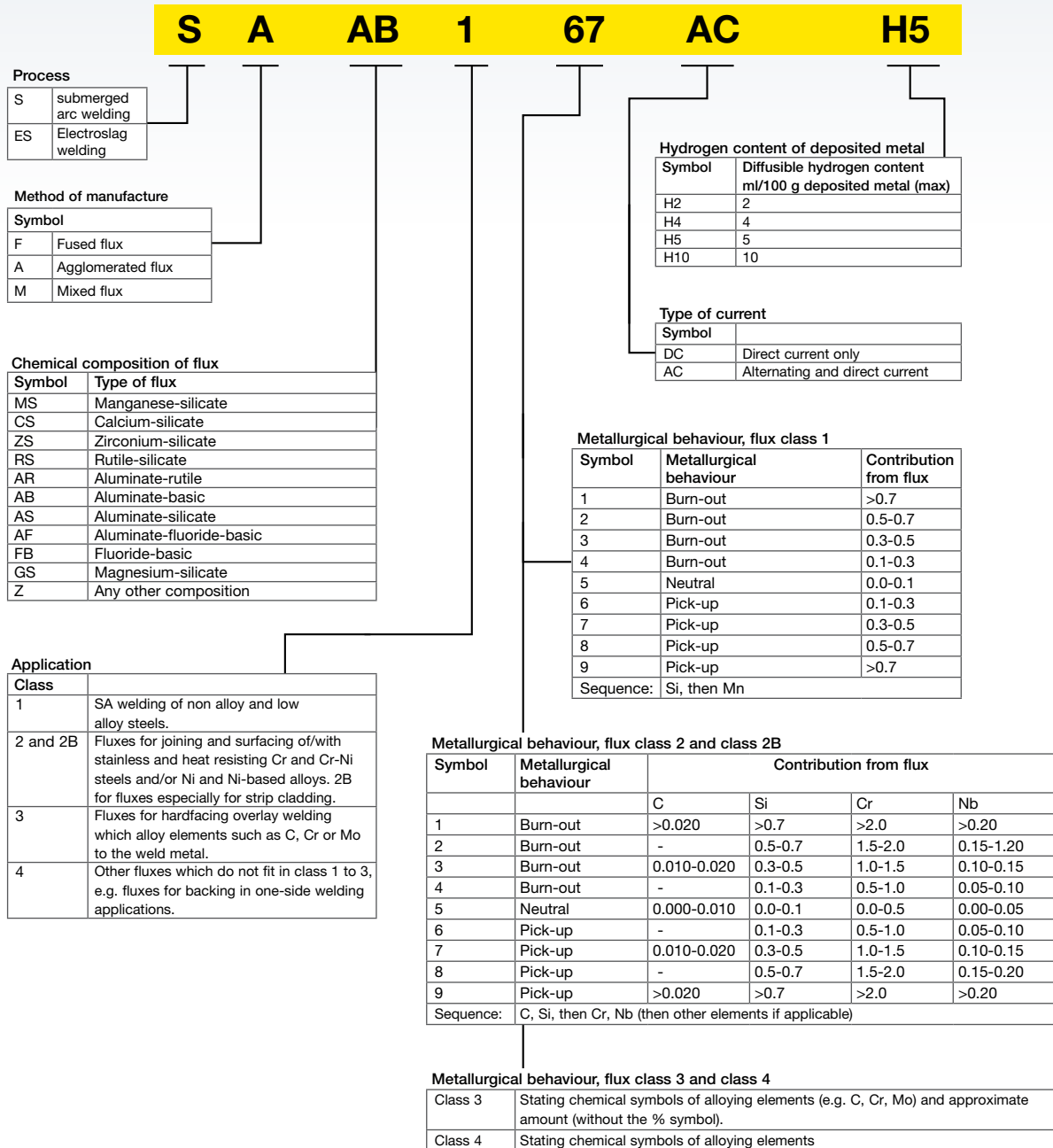

EN ISO 14171-A: GUIDE TO THE EN ISO CODING, EN ISO 14171-A FOR FLUX/WIRE COMBINATIONS
EXAMPLE: OK FLUX 10.72 / OK AUTROD 12.22 - S 38 5 AB S2Si

S 38 5 AB S2Si

Process

S	submerged arc welding
---	-----------------------

Symbol for the tensile properties - multi-run technique

Symbol	Yield Strength - min. [MPa]	Tensile Strength [MPa]	Elongation - min. [%]
35	355	440 – 570	22
38	380	470 – 600	20
42	420	500 – 640	20
46	460	530 – 680	20
50	500	560 – 720	18

Symbol for the tensile properties - two-run technique

Symbol	Minimum Parent Material Yield Strength [MPa]	Minimum Tensile Strength of the Welded Joint [MPa]
2T	275	370
3T	355	470
4T	420	520
5T	500	600

Chemical composition of flux

Symbol	Type of flux
MS	Manganese-silicate
CS	Calcium-silicate
ZS	Zirconium-silicate
RS	Rutile-silicate
AR	Aluminate-rutile
AB	Aluminate-basic
AS	Aluminate-silicate
AF	Aluminate-fluoride-basic
FB	Fluoride-basic
GS	Magnesium-silicate
Z	Any other composition

Symbol for impact properties

Symbol	Charpy-V Impact - min. [J]	Temp. [°C]
Z	No requirements	
A	47	20
0	47	0
2	47	-20
3	47	-30
4	47	-40
5	47	-50
6	47	-60
7	47	-70
8	47	-80

Type of wire according to EN ISO 14171-A and chemical composition of wire electrode

Symbol	C	Si	Mn	Ni	Mo	Cr	Other
SZ	Any other agreed composition						
S1	0.05-0.15	-0.15	0.35-0.60	-0.15	-0.15	-0.15	*
S2	0.07-0.15	-0.15	0.80-1.30	-0.15	-0.15	-0.15	*
S3	0.07-0.15	-0.15	1.30-1.75	-0.15	-0.15	-0.15	*
S4	0.07-0.15	-0.15	1.75-2.25	-0.15	-0.15	-0.15	*
S1Si	0.07-0.15	0.15-0.40	0.35-0.60	-0.15	-0.15	-0.15	*
S2Si	0.07-0.15	0.15-0.40	0.80-1.30	-0.15	-0.15	-0.15	*
S2Si2	0.07-0.15	0.40-0.60	0.80-1.20	-0.15	-0.15	-0.15	*
S3Si	0.07-0.15	0.15-0.40	1.30-1.85	-0.15	-0.15	-0.15	*
S4Si	0.07-0.15	0.15-0.40	1.85-2.25	-0.15	-0.15	-0.15	*
S1Mo	0.05-0.15	0.05-0.25	0.35-0.60	-0.15	0.45-0.65	-0.15	*
S2Mo	0.07-0.15	0.05-0.25	0.80-1.30	-0.15	0.45-0.65	-0.15	*
S2MoTiB	0.05-0.15	0.15-0.35	1.00-1.35	-	0.40-0.65	-	**
S3Mo	0.07-0.15	0.05-0.25	1.30-1.75	-0.15	0.45-0.65	-0.15	*
S4Mo	0.07-0.15	0.05-0.25	1.75-2.25	-0.15	0.45-0.65	-0.15	*
S2Ni1	0.07-0.15	0.05-0.25	0.80-1.30	0.80-1.20	-0.15	-0.15	*
S2Ni1.5	0.07-0.15	0.05-0.25	0.80-1.30	1.20-1.80	-0.15	-0.15	*
S2Ni2	0.07-0.15	0.05-0.25	0.80-1.30	1.80-2.40	-0.15	-0.15	*
S2Ni3	0.07-0.15	0.05-0.25	0.80-1.30	2.80-3.70	-0.15	-0.15	*
S2Ni1Mo	0.07-0.15	0.05-0.25	0.80-1.30	0.80-1.20	0.45-0.65	-0.20	*
S3Ni1.5	0.07-0.15	0.05-0.25	1.30-1.70	1.20-1.80	-0.15	-0.20	*
S3Ni1Mo	0.07-0.15	0.05-0.25	1.30-1.80	0.80-1.20	0.45-0.65	-0.20	*
S3Ni1Mo0,2	0.07-0.15	0.10-0.35	1.20-1.60	0.80-1.2	0.15-0.30	-0.15	P, S: -0.015
S3Ni1.5Mo	0.07-0.15	0.05-0.25	1.20-1.80	1.20-1.80	0.30-0.50	-0.20	*
S2Ni1Cu	0.06-0.12	0.15-0.35	0.70-1.20	0.65-0.90	0.15	-0.40	Cu: 0.40-0.65
S3Ni1Cu	0.05-0.15	0.15-0.40	1.20-1.70	0.60-1.20	0.15	-0.15	Cu: 0.30-0.60

*) Cu: -0.30 P, S: 0.025 or 0.020 Al: -0.030
 **) Ti: 0.10-0.20 B: 0.005-0.020

All-weld metal chemical composition of tubular cored electrode-flux combinations (extract of complete table)

Symbol	Chemical composition %			
	Mn	Ni	Mo	Cu
T3	1.4-2.0	-	-	0.3
T3Ni1	1.4-2.0	0.6-1.2	-	0.3

SFA/AWS A5.17: SPECIFICATION FOR CARBON STEEL ELECTRODES AND FLUXES FOR SUBMERGED ARC WELDING

Example: OK Flux 10.71 / OK Autrod 12.22:
SFA/AWS A5.17: F7A5-EM12K

F 7 A 5 - EM12K

Indicates a submerged arc welding flux.

Symbol for tensile properties

Symbol for heat treatment

Symbol for impact properties

Chemical composition of wire electrodes

	Tensile Strength [psi]	Yield Strength - min. [psi]	Elongation [%]	(Tensile Strength) ([MPa])	(Yield Strength - min.) ([MPa])
6	60.000 - 80.000	48.000	22	(415 - 550)	(330)
7	70.000 - 95.000	58.000	22	(480 - 650)	(400)

A	As welded
P	Postweld heat treated (PWHT); 620°C / 1h

Symbol	Temp [°F]	Charpy-V Impact - min. [ft * lbf]	(Temp) ([°C])	(Charpy-V Impact - min.) ([J])
0	0	20	(- 18)	(27)
2	- 20	20	(- 29)	(27)
4	- 40	20	(- 40)	(27)
5	- 50	20	(- 46)	(27)
6	- 60	20	(- 51)	(27)
8	- 80	20	(- 62)	(27)
Z	no requirements			

Chemical composition for solid electrodes (extract of table)

Symbol	Chemical composition in %					
	C	Mn	Si	S	P	Cu (including Cu-coating)
EL12	0.04 - 0.14	0.25 - 0.60	0.10	0.030	0.030	0.35
EM12	0.06 - 0.15	0.80 - 1.25	0.10	0.030	0.030	0.35
EM12K	0.05 - 0.15	0.80 - 1.25	0.10 - 0.35	0.030	0.030	0.35
EH12K	0.06 - 0.15	1.50 - 2.00	0.25 - 0.65	0.025	0.025	0.35
EH14	0.10 - 0.20	1.70 - 2.20	0.10	0.030	0.030	0.35

Single values are maximum.

Chemical composition for composite electrode weld metal

Symbol	Chemical composition in %					
	C	Mn	Si	S	P	Cu
EC1	0.15	1.80	0.90	0.035	0.035	0.35
ECG	Not specified					

Single values are maximum.

EN ISO 24598-A: WELDING CONSUMABLES - SOLID WIRE ELECTRODES, TUBULAR CORED ELECTRODES AND ELECTRODE/FLUX COMBINATIONS FOR SUBMERGED ARC WELDING OF CREEP-RESISTING STEELS

Example: OK Flux 10.63 / OK Autrod 13.10 SC
EN ISO 24598-A: S S CrMo1 FB

S S CrMo1 FB

Process

S submerged arc welding

Type of wire

S	Solid wire
T	Tubular wire

Type of flux

FB Fluoride-basic

In accordance with EN ISO 14174

Chemical composition of solid wire electrodes for submerged arc welding (extract of table)

Symbol	Chemical composition in %										
	C	Si	Mn	P	S	Cr	Ni	Mo	Cu	V	Other
Mo	0.08 - 0.15	0.05 - 0.25	0.80 - 1.20	0.025	0.025	0.2	0.3	0.45 - 0.65	0.3	0.03	Nb: 0.01
MnMo	0.08 - 0.15	0.05 - 0.25	1.30 - 1.70	0.025	0.025	0.2	0.3	0.45 - 0.65	0.3	0.03	Nb: 0.01
CrMo1	0.08 - 0.15	0.05 - 0.25	0.60 - 1.00	0.020	0.020	0.90 - 1.30	0.3	0.40 - 0.65	0.3	0.03	Nb: 0.01
CrMo2	0.08 - 0.15	0.05 - 0.25	0.30 - 0.70	0.020	0.020	2.2 - 2.8	0.3	0.90 - 1.15	0.3	0.03	Nb: 0.01
CrMo5	0.03 - 0.10	0.20 - 0.50	0.40 - 0.75	0.020	0.020	5.5 - 6.5	0.3	0.50 - 0.80	0.3	0.03	Nb: 0.01
CrMo91	0.07 - 0.15	0.60	0.4 - 1.5	0.020	0.020	8.0 - 10.5	0.4 - 1.0	0.80 - 1.20	0.25	0.15 - 0.30	Nb: 0.03 - 0.10 N: 0.02 - 0.07
Z	Any other agreed composition										

Single values shown in the table are maximum values.

Chemical composition for all weld metal deposits (extract of table)

Symbol	Chemical composition in %										
	C	Si	Mn	P	S	Cr	Ni	Mo	Cu	V	Other
Mo	0.15	0.80	1.4	0.030	0.030	0.2	0.3	0.40 - 0.65	0.35	0.03	Nb: 0.01
MnMo	0.15	0.80	2.0	0.030	0.030	0.2	0.3	0.40 - 0.65	0.35	0.03	Nb: 0.01
CrMo1	0.15	0.80	1.20	0.030	0.030	0.80 - 1.30	0.25	0.35 - 0.65	0.40	0.03	Nb: 0.01
CrMo2	0.15	0.80	1.20	0.030	0.030	2.0 - 2.8	0.3	0.80 - 1.15	0.35	0.03	Nb: 0.01
CrMo5	0.10	0.80	1.20	0.030	0.030	4.5 - 6.50	0.3	0.45 - 0.80	0.35	0.03	Nb: 0.01
CrMo91	0.15	0.80	1.80	0.030	0.030	8.0 - 10.5	1.0	0.70 - 1.20	0.35	0.10 - 0.30	Nb: 0.02 - 0.10 N: 0.02 - 0.07
Z	Any other agreed composition										

Single values shown in the table are maximum values.

Mechanical properties of all weld metal deposits (Extract of table)

Symbol	Yield strength - min.	Tensile strength - min.	Elongation - min.	Toughness at +20°C - min.		Heat treatment		
	Rp0,2	Rm	A	Average of 3	Single value	Preheat, interpass	PWHT Temp.	PWHT Time
	[MPa]	[MPa]	[%]	[J]	[J]	[°C]	[°C]	[minutes]
Mo	355	510	22	47	38	< 200	-	-
MnMo	355	510	22	47	38	< 200	-	-
CrMo1	355	510	20	47	38	150 - 250	660 - 700	60
CrMo2	400	500	18	47	38	200 - 300	690 - 750	60
CrMo5	400	590	17	47	38	200 - 300	730 - 760	60
CrMo91	415	585	17	47	38	250 - 350	750 - 760	180
Z	Any other agreed composition							

SFA/AWS A5.23: SPECIFICATION FOR LOW-ALLOY STEEL ELECTRODES AND FLUXES FOR SUBMERGED ARC WELDING

Multiple Pass Classification System

Example: OK Flux 10.62 / OK Autrod 13.24:
SFA/AWS A5.23: F8A10-ENi6-Ni6

F 8 A 10 - ENi6 - Ni6



	Tensile strength [psi]	Yield strength - min. [psi]	Elongation - min. [%]	(Tensile strength) [MPa]	(Yield strength - min.) [MPa]
7	70,000 - 95,000	58,000	22	(480 - 650)	(400)
8	80,000 - 100,000	68,000	20	(550 - 690)	(470)
9	90,000 - 110,000	78,000	17	(620 - 760)	(540)
10	100,000 - 120,000	88,000	16	(690 - 830)	(610)
11	110,000 - 130,000	98,000	15	(760 - 900)	(680)
12	120,000 - 140,000	108,000	14	(830 - 970)	(740)
13	130,000 - 150,000	118,000	14	(900 - 1030)	(810)

A As welded
P Postweld heat treated (PWHT); depending on alloy, 620°C, 690°C and other temp. / Th (B91: 2h)

Chemical composition of wire electrodes (extract of complete table)

Symbol	Chemical composition in %										
	C	Mn	Si	S	P	Cr	Ni	Mo	Cu (including Cu-coating)	Other	
EA2	0.05 - 0.17	0.95 - 1.35	0.20	0.025	0.025	0.025	-	0.45 - 0.65	0.35	-	
EA2TB	0.05 - 0.17	0.95 - 1.35	0.35	0.025	0.025	0.025	-	0.45 - 0.65	0.35	see 1.)	
EA4	0.05 - 0.17	1.20 - 1.70	0.20	0.025	0.025	0.025	-	0.45 - 0.65	0.35	-	
EB2R	0.07 - 0.15	0.45 - 1.00	0.05 - 0.30	0.010	0.010	1.00 - 1.75	-	0.45 - 0.65	0.15	see 2.)	
EB3R	0.05 - 0.15	0.40 - 0.80	0.05 - 0.30	0.010	0.010	2.25 - 3.00	-	0.90 - 1.00	0.15	see 2.)	
EB6	0.10	0.35 - 0.70	0.05 - 0.50	0.025	0.025	4.50 - 6.50	-	0.45 - 0.70	0.35	-	
EB91	0.07 - 0.13	1.25	0.50	0.010	0.010	8.50 - 10.50	1.00	0.85 - 1.15	0.10	see 3.)	
EN1	0.12	0.75 - 1.25	0.05 - 0.30	0.020	0.020	0.15	0.75 - 1.25	0.30	0.35	-	
EN2	0.12	0.75 - 1.25	0.05 - 0.30	0.020	0.020	0.15	2.10 - 2.90	-	0.35	-	
EN3	0.13	0.60 - 1.20	0.05 - 0.30	0.020	0.020	0.15	3.10 - 3.80	-	0.35	-	
ENi6	0.07 - 0.15	1.20 - 1.60	0.05 - 0.30	0.020	0.020	0.15	0.75 - 1.25	0.10 - 0.30	0.35	-	
EG	not specified										
(EC)	(composite electrode)										

Single values are maximum.
1.) Ti: 0.05 - 0.30; B: 0.005 - 0.030 2.) As: 0.005; Sn: 0.005; Sb: 0.005 3.) V: 0.15 - 0.25; Nb: 0.02 - 0.10; N: 0.03 - 0.07; Al: 0.04

Chemical composition of weld metal (extract of complete table)

Symbol	Chemical composition in %										
	C	Mn	Si	S	P	Cr	Ni	Mo	Cu (including Cu-coating)	Other	
A2	0.12	1.40	0.80	0.030	0.030	-	-	0.40 - 0.65	0.35	-	
A3	0.15	2.10	0.80	0.030	0.030	-	-	0.40 - 0.65	0.35	-	
A4	0.15	1.60	0.80	0.030	0.030	-	-	0.40 - 0.65	0.35	-	
B2	0.05 - 0.15	1.20	0.80	0.030	0.030	1.00 - 1.50	-	0.40 - 0.65	0.35	-	
B2R	0.05 - 0.15	1.20	0.80	0.010	0.010	1.00 - 1.50	-	0.40 - 0.65	0.15	see 1.)	
B3	0.05 - 0.15	1.20	0.80	0.030	0.030	2.00 - 2.50	-	0.90 - 1.20	0.35	-	
B3R	0.05 - 0.15	1.20	0.80	0.010	0.010	2.00 - 2.50	-	0.90 - 1.20	0.15	see 1.)	
B91	0.08 - 0.13	1.20	0.80	0.010	0.010	8.0 - 10.5	0.80	0.85 - 1.20	0.25	see 2.)	
Ni1	0.12	1.60	0.80	0.025	0.030	0.15	0.75 - 1.10	0.35	0.35	see 3.)	
Ni2	0.12	1.60	0.80	0.025	0.030	-	2.00 - 2.90	-	0.35	-	
Ni3	0.12	1.60	0.80	0.025	0.030	0.15	2.80 - 3.80	-	0.35	-	
Ni6	0.14	1.60	0.80	0.025	0.030	-	0.70 - 1.10	0.10 - 0.35	0.35	-	
F3	0.17	1.25 - 2.25	0.80	0.030	0.030	-	0.70 - 1.10	0.40 - 0.65	0.35	-	
G	As agreed between supplier and purchaser										

Single values are maximum. Weld metals generated with a composite electrode have the prefix "EC" before the appropriate electrode designation.
1.) As: 0.005; Sn: 0.005; Sb: 0.005 2.) Mn + Ni = 1.40 max; Nb: 0.02 - 0.10; N: 0.02 - 0.07; V: 0.15 - 0.25; Al: 0.04 3.) Ti+V+Zr: 0.05

Symbol for impact properties

Symbol	Charpy-V impact		(Temp) [°C]
	Temp [°F]	Charpy-V impact - min. [ft * lbf]	
0	0	20	(-18)
2	-20	20	(-29)
4	-40	20	(-40)
5	-50	20	(-46)
6	-60	20	(-51)
8	-80	20	(-62)
10	-100	20	(-73)
15	-150	20	(-101)
Z	no requirements		

SFA/AWS A5.23: SPECIFICATION FOR LOW-ALLOY STEEL ELECTRODES AND FLUXES FOR SUBMERGED ARC WELDING TWO-RUN CLASSIFICATION SYSTEM

Example: OK Flux 10.74 / OK Autrod 13.64
SFA/AWS A5.23: F8TA6-EA2TiB

F 8 T A 6 G - EA2TiB



A	As welded
P	Postweld heat treated (PWHT); depending on alloy, 620°C, 690°C and other temp. / 1h

G	When base steel is different from standard (A131 Grade AH36, A516 Grade 70 or chemically equivalent)
---	------------------------------------------------------------------------------------------------------

	Tensile Strength	Yield Strength	Elongation	(Tensile Strength)	(Yield Strength)
	[psi]	[psi]	[%]	([MPa])	([MPa])
6T	60 000	50 000	22	(410)	(340)
7T	70 000	60 000	22	(480)	(410)
8T	80 000	70 000	20	(550)	(480)
9T	90 000	80 000	17	(620)	(550)
10T	100 000	90 000	16	(690)	(620)
11T	110 000	100 000	15	(760)	(690)
12T	120 000	110 000	14	(830)	(760)
13T	130 000	120 000	14	(900)	(830)

All values are minimum requirements.

Symbol for impact properties

Symbol	Temp	Charpy-V impact - min.	(Temp)	(Charpy-V impact - min.)
	[°F]	[ft * lbf]	([°C])	([J])
0	0	20	(- 18)	(27)
2	-20	20	(- 29)	(27)
4	-40	20	(- 40)	(27)
5	-50	20	(- 46)	(27)
6	-60	20	(- 51)	(27)
8	-80	20	(- 62)	(27)
10	-100	20	(- 73)	(27)
15	-150	20	(- 101)	(27)
Z	no requirements			

Chemical composition of wire electrodes (extract of complete table)

Symbol	Chemical composition in %									
	C	Mn	Si	S	P	Cr	Ni	Mo	Cu (including Cu-coating)	Other
EA2	0.05 - 0.17	0.95 - 1.35	0.20	0.025	0.025	-	-	0.45 - 0.65	0.35	-
EA2TiB	0.05 - 0.17	0.95 - 1.35	0.35	0.025	0.025	-	-	0.45 - 0.65	0.35	see 1.)
EA4	0.05 - 0.17	1.20 - 1.70	0.20	0.025	0.025	-	-	0.45 - 0.65	0.35	-
EB2R	0.07 - 0.15	0.45 - 1.00	0.05 - 0.30	0.010	0.010	1.00 - 1.75	-	0.45 - 0.65	0.15	see 2.)
EB3R	0.05 - 0.15	0.40 - 0.80	0.05 - 0.30	0.010	0.010	2.25 - 3.00	-	0.90 - 1.00	0.15	see 2.)
EB6	0.10	0.35 - 0.70	0.05 - 0.50	0.025	0.025	4.50 - 6.50	-	0.45 - 0.70	0.35	-
EB91	0.07 - 0.13	1.25	0.50	0.010	0.010	8.50 - 10.50	1.00	0.85 - 1.15	0.10	see 3.)
ENi1	0.12	0.75 - 1.25	0.05 - 0.30	0.020	0.020	0.15	0.75 - 1.25	0.30	0.35	-
ENi2	0.12	0.75 - 1.25	0.05 - 0.30	0.020	0.020	-	2.10 - 2.90	-	0.35	-
ENi3	0.13	0.60 - 1.20	0.05 - 0.30	0.020	0.020	0.15	3.10 - 3.80	-	0.35	-
ENi6	0.07 - 0.15	1.20 - 1.60	0.05 - 0.30	0.020	0.020	-	0.75 - 1.25	0.10 - 0.30	0.35	-
EG	not specified									
(EC)	(composite electrode)									

Single values are maximum.
1.) Ti: 0.05 - 0.30; B: 0.005 - 0.030 2.) As: 0.005; Sn: 0.005; Sb: 0.005 3.) V: 0.15 - 0.25; Nb: 0.02 - 0.10; N: 0.03 - 0.07; Al: 0.04

EN ISO 26304-A: WELDING CONSUMABLES – SOLID WIRE ELECTRODES, TUBULAR CORED ELECTRODES AND ELECTRODE-FLUX-COMBINATIONS FOR SAW OF HIGH STRENGTH STEELS

Example: OK Flux 10.62 / OK Autrod 13.40

EN ISO 26304-A:

S 55 6 FB S3Ni1Mo

S 55 6 FB S3Ni1Mo

Process

S	submerged arc welding
---	-----------------------

Symbol for the tensile properties

Symbol	Yield Strength - min. [MPa]	Tensile Strength [MPa]	Elongation - min. [%]
55	550	640 – 820	18
62	620	700 – 890	18
69	690	770 – 940	17
79	790	880 – 1080	16
89	890	940 – 1180	15

Symbol for impact properties

Symbol	Charpy-V Impact -min. [J]	Temp [°C]
Z	No requirements	
A	47	+20
0	47	0
2	47	-20
3	47	-30
4	47	-40
5	47	-50
6	47	-60

Symbol	Type of flux
MS	Manganese-silicate
CS	Calcium-silicate
ZS	Zirconium-silicate
RS	Rutile-silicate
AR	Aluminate-rutile
AB	Aluminate-basic
AS	Aluminate-silicate
AF	Aluminate-fluoride-basic
FB	Fluoride-basic
GS	Magnesium-silicate
Z	Any other composition

Chemical composition of wire electrodes

Symbol	Chemical composition in % 1) 2) 3)									
	C	Si	Mn	P	S	Cr	Ni	Mo	Cu	Total other
SZ	Any other agreed composition									
S2Ni1Mo	0.07-0.15	0.05-0.25	0.80-1.30	0.020	0.020	0.20	0.80-1.20	0.45-0.65	0.30	0.50
S3Ni1Mo	0.07-0.15	0.05-0.35	1.30-1.80	0.020	0.020	0.20	0.80-1.20	0.45-0.65	0.30	0.50
S2Ni2Mo	0.05-0.09	0.15	1.10-1.40	0.015	0.015	0.15	2.00-2.50	0.45-0.60	0.30	0.50
S2Ni3Mo	0.08-0.12	0.10-0.25	0.80-1.20	0.020	0.020	0.15	2.80-3.20	0.10-0.25	0.30	0.50
S1Ni2,5CrMo	0.07-0.15	0.10-0.25	0.45-0.75	0.020	0.020	0.50-0.85	2.10-2.60	0.40-0.70	0.30	0.50
S3Ni2,5CrMo	0.07-0.15	0.10-0.25	1.20-1.80	0.020	0.020	0.30-0.85	2.00-2.60	0.40-0.70	0.30	0.50
S3Ni1,5CrMo	0.07-0.14	0.05-0.15	1.30-1.50	0.020	0.020	0.15-0.35	1.50-1.70	0.30-0.50	0.30	0.50
S3Ni1,5Mo	0.07-0.15	0.05-0.25	1.20-1.80	0.020	0.020	0.20	1.20-1.80	0.30-0.50	0.30	0.50
S4Ni2CrMo	0.08-0.11	0.30-0.40	1.80-2.00	0.015	0.015	0.85-1.00	2.10-2.60	0.55-0.70	0.30	0.50

- 1.) Al, Sn, As and Sb ≤ 0.02% each and Ti, Pb and N ≤ 0.01%
 2.) Cu: Including the cu-coating
 3.) Single vales shown in the table are maximum values.

EN ISO 14343-A: WELDING CONSUMABLES - WIRE ELECTRODES, STRIP ELECTRODES, WIRES AND RODS FOR ARC WELDING OF STAINLESS AND HEAT-RESISTING STEELS (EXTRACT)

Example: OK Autrod 308L:

EN ISO 14343-A - S 19 9 L

S 19 9 L (308L)

Symbol for the process: (Box 1.)

The nominal chemical composition of wire or rod.

Alloy type (Box 2.)

Box 1.

Symbol	Welding Process
G	Gas metal arc welding
W	Gas tungsten arc welding
P	Plasma arc welding
S	Submerged arc welding
B	Strip cladding
L	Laser beam welding

Box 2.

Nominal composition	Alloy Type	Chemical composition in %										
		C	Si	Mn	P	S	Cr	Ni	Mo	N	Cu	Other
19 9 L		0.03	0.65	1.0-2.5	0.03	0.02	19.0-21.0	9.0-11.0	0.5	-	0.5	-
	308L	0.03	0.65	1.0-2.5	0.03	0.03	19.5-22.0	9.0-11.0	0.75	-	0.75	-
19 9 H		0.04-0.08	1.0	1.0-2.5	0.03	0.02	18.0-21.0	9.0-11.0	0.5	-	0.5	-
	308H	0.04-0.08	0.65	1.0-2.5	0.03	0.03	19.5-22.0	9.0-11.0	0.5	-	0.75	-
18 8 Mn		0.20	1.2	5.0-8.0	0.03	0.03	17.0-20.0	7.0-10.0	0.5	-	0.5	-
23 12 L		0.03	0.65	1.0-2.5	0.03	0.02	22.0-25.0	11.0-14.0	0.5	-	0.5	-
	309L	0.03	0.65	1.0-2.5	0.03	0.03	23.0-25.0	12.0-14.0	0.75	-	0.75	-
23 12 2 L		0.03	1.0	1.0-2.5	0.03	0.02	21.0-25.0	11.0-15.5	2.0-3.5	-	0.5	-
	309LMo	0.03	0.65	1.0-2.5	0.03	0.03	23.0-25.0	12.0-14.0	2.0-3.0	-	0.75	-
25 20		0.08-0.15	2.0	1.0-2.5	0.03	0.02	24.0-27.0	18.0-22.0	0.5	-	0.5	-
	310	0.08-0.15	0.65	1.0-2.5	0.03	0.03	25.0-28.0	20.0-22.5	0.75	-	0.75	-
29 9		0.15	1.0	1.0-2.5	0.03	0.02	28.0-32.0	8.0-12.0	0.5	-	0.5	-
	312	0.15	0.65	1.0-2.5	0.03	0.03	28.0-32.0	8.0-10.5	0.75	-	0.75	-
19 12 3 L		0.03	0.65	1.0-2.5	0.03	0.02	18.0-20.0	11.0-14.0	2.5-3.0	-	0.5	-
	316L	0.03	0.65	1.0-2.5	0.03	0.03	18.0-20.0	11.0-14.0	2.0-3.0	-	0.75	-
19 12 3 H		0.04-0.08	1.0	1.0-2.5	0.03	0.02	18.0-20.0	11.0-14.0	2.0-3.0	-	0.5	-
	316H	0.04-0.08	0.65	1.0-2.5	0.03	0.03	18.0-20.0	11.0-14.0	2.0-3.0	-	0.75	-
18 15 3 L		0.03	1.0	1.0-4.0	0.03	0.02	17.0-20.0	13.0-16.0	2.5-4.0	-	0.5	-
	317L	0.03	0.65	1.0-2.5	0.03	0.03	18.5-20.5	13.0-15.0	3.0-4.0	-	0.75	-
19 12 3 Nb		0.08	0.65	1.0-2.5	0.03	0.02	18.0-20.0	11.0-14.0	2.5-3.0	-	0.5	Nb=10xC to 1.0
	318	0.08	0.65	1.0-2.5	0.03	0.03	18.0-20.0	11.0-14.0	2.0-3.0	-	0.75	Nb=8xC to 1.0
19 9 Nb		0.08	0.65	1.0-2.5	0.03	0.02	19.0-21.0	9.0-11.0	0.5	-	0.5	Nb=10xC to 1.0
	347	0.08	0.65	1.0-2.5	0.03	0.03	19.0-21.5	9.0-11.0	0.75	-	0.75	Nb=10xC to 1.0
20 25 5 Cu L		0.03	1.0	1.0-4.0	0.03	0.02	19.0-22.0	24.0-27.0	4.0-6.0	-	1.0-2.0	-
	385	0.025	0.5	1.0-2.5	0.02	0.03	19.5-21.5	24.0-26.0	4.2-5.2	-	1.2-2.0	-
20 16 3 Mn L		0.03	1.0	5.0-9.0	0.03	0.02	19.0-22.0	15.0-18.0	2.5-4.5	-	0.5	-
25 22 2 N L		0.03	1.0	3.5-6.5	0.03	0.02	24.0-27.0	21.0-24.0	1.5-3.0	0.1-0.2	0.5	-
22 9 3 N L		0.03	1.0	2.5	0.03	0.02	21.0-24.0	7.0-10.0	2.5-4.0	0.1-0.2	0.5	-
	2209	0.03	0.90	0.5-2.0	0.03	0.03	21.5-23.5	7.5-9.5	2.5-3.5	0.08-0.2	0.75	-
23 7 N L		0.03	1.0	2.5	0.03	0.02	22.5-25.5	6.5-9.5	0.8	0.10-0.20	0.5	-
25 9 4 N L	2594	0.03	1.0	2.5	0.03	0.02	24.0-27.0	8.0-10.5	2.5-4.5	0.20-0.30	1.5	W 1.0
	410NiMo	0.03	0.5	0.6	0.03	0.03	12.0-14.0	0.75	0.75	-	0.75	-

EN ISO 18274: WELDING CONSUMABLES - WIRE AND STRIP ELECTRODES, WIRES AND RODS FOR ARC WELDING OF NICKEL AND NICKEL ALLOYS (EXTRACT)

Example: OK Autrod NiCrMo-3:
EN ISO 18274 - S Ni6625
(NiCr22Mo9Nb)

S Ni6625 (NiCr22Mo9Nb)

Symbol for the product form: (Box 1.)

Symbol for the chemical composition of strip, wire or rod.

Chemical symbol (Box 2.)

Symbol	Product form
S	Solid wire (electrode), solid rod
B	Solid strip electrode

Symbol	Chemical composition in %									
	C	Si	Mn	Cr	Ni	Mo	Nb	Cu	Fe	Other
Ni6082 (NiCr20Mn3Nb)	0.1	0.5	2.5-3.5	18.0-22.0	Min. 67.0	-	2.0-3.0	0.5	3.0	Ti: 0.7 P: 0.03
Ni6625 (NiCr22Mo9Nb)	0.1	0.5	0.5	20.0-23.0	Min. 58.0	8.0-10.0	3.2-4.1	0.5	5.0	Ti: 0.4 Al: 0.4
Ni6276 (NiCr15Mo16Fe6W4)	0.02	0.08	1.0	14.5-16.5	Min. 50.0	15.0-17.0	-	0.5	4.0-7.0	Co: 2.5 W: 3.0-4.5
Ni6059 (NiCr23Mo16)	0.01	0.1	0.5	22.0-24.0	Min. 56.0	15.0-16.5	-	0.5	2.0-5.0	Ti: 0.5 Al: 0.1-0.4

SFA/AWS A5.4: SPECIFICATION FOR STAINLESS STEEL ELECTRODES FOR SHIELDED METAL ARC WELDING (EXTRACT)

Example: OK 61.30:
SFA/AWS A5.4: E308L

E 308L

The nominal chemical composition of the filler metal. (Box 1.)

Symbol	Chemical composition in %										
	C	Si	Mn	P	S	Cr	Ni	Mo	N	Cu	Other
E307	0.04-0.14	1.0	3.30-4.75	0.04	0.03	18.0-21.5	9.0-10.7	0.50-1.5	-	0.75	-
E308L	0.04	1.0	0.5-2.5	0.04	0.03	18.0-21.0	9.0-11.0	0.75	-	0.75	-
E308H	0.04-0.08	1.0	0.5-2.5	0.04	0.03	18.0-21.0	9.0-11.0	0.75	-	0.75	-
E309L	0.04	1.0	0.5-2.5	0.04	0.03	22.0-25.0	12.0-14.0	0.75	-	0.75	-
E309LMO	0.04	1.0	0.5-2.5	0.04	0.03	22.0-25.0	12.0-14.0	2.0-3.0	-	0.75	-
E310	0.08-0.20	0.75	1.0-2.5	0.03	0.03	25.0-28.0	20.0-22.5	0.75	-	0.75	-
E312	0.15	1.0	0.5-2.5	0.04	0.03	28.0-32.0	8.0-10.5	0.75	-	0.75	-
E316L	0.04	1.0	0.5-2.5	0.04	0.03	17.0-20.0	11.0-14.0	2.0-3.0	-	0.75	-
E316H	0.04-0.08	1.0	0.5-2.5	0.04	0.03	17.0-20.0	11.0-14.0	2.0-3.0	-	0.75	-
E317L	0.04	1.0	0.5-2.5	0.04	0.03	18.0-21.0	12.0-14.0	3.0-4.0	-	0.75	-
E318	0.08	1.0	0.5-2.5	0.04	0.03	17.0-20.0	11.0-14.0	2.0-3.0	-	0.75	Nb=6xCmin/1.0max
E347	0.08	1.0	0.5-2.5	0.04	0.03	18.0-21.0	9.0-11.0	0.75	-	0.75	Nb=8xCmin/1.0max
E385	0.03	0.9	1.0-2.5	0.03	0.02	19.5-21.5	24.0-26.0	4.2-5.2	-	1.2-2.0	-
E2209	0.04	1.0	0.5-2.0	0.04	0.03	21.5-23.5	8.5-10.5	2.5-3.5	0.08-0.20	0.75	-
E2594	0.04	1.0	0.5-2.0	0.04	0.03	24.0-27.0	8.0-10.5	3.5-4.5	0.20-0.30	0.75	-

SFA/AWS A5.9: BARE STAINLESS STEEL WELDING ELECTRODES AND RODS (EXTRACT)

Example: OK Autrod 316L:

SFA/AWS A5.9: ER316L

ER 316L

Symbol for the product:

ER = Solid wires (electrodes or rods)

EC = Cored wires

EQ = Strip electrodes

The nominal chemical composition of the filler metal. (Box 1.)

AWS Classification	C	Si	Mn	P	S	Cr	Ni	Mo	N	Cu	Other
ER307	0.04-0.14	0.30-0.65	3.3-4.75	0.03	0.03	19.5-22.0	8.0-10.7	0.50-1.5	-	0.75	-
ER308L	0.03	0.30-0.65	1.0-2.5	0.03	0.03	19.5-22.0	9.0-11.0	0.75	-	0.75	-
ER308H	0.04-0.08	0.30-0.65	1.0-2.5	0.03	0.03	19.5-22.0	9.0-11.0	0.50	-	0.75	-
ER309L	0.03	0.30-0.65	1.0-2.5	0.03	0.03	23.0-25.0	12.0-14.0	0.75	-	0.75	-
ER309LMo	0.03	0.30-0.65	1.0-2.5	0.03	0.03	23.0-25.0	12.0-14.0	2.0-3.0	-	0.75	-
ER310	0.08-0.15	0.30-0.65	1.0-2.5	0.03	0.03	25.0-28.0	20.0-22.5	0.75	-	0.75	-
ER312	0.15	0.30-0.65	1.0-2.5	0.03	0.03	28.0-32.0	8.0-10.5	0.75	-	0.75	-
ER316L	0.03	0.30-0.65	1.0-2.5	0.03	0.03	18.0-20.0	11.0-14.0	2.0-3.0	-	0.75	-
ER316H	0.04-0.08	0.30-0.65	1.0-2.5	0.03	0.03	18.0-20.0	11.0-14.0	2.0-3.0	-	0.75	-
ER317L	0.03	0.30-0.65	1.0-2.5	0.03	0.03	18.5-20.5	13.0-15.0	3.0-4.0	-	0.75	-
ER318	0.08	0.30-0.65	1.0-2.5	0.03	0.03	18.0-20.0	11.0-14.0	2.0-3.0	-	0.75	Nb=8xCmin/1.0max
ER347	0.08	0.30-0.65	1.0-2.5	0.03	0.03	19.0-21.5	9.0-11.0	0.75	-	0.75	Nb=10xCmin/1.0max
ER385	0.025	0.50	1.0-2.5	0.02	0.03	19.5-21.5	24.0-26.0	4.2-5.2	-	1.2-2.0	-
ER2209	0.03	0.90	0.50-2.0	0.03	0.03	21.5-23.5	7.5-9.5	2.5-3.5	0.08-0.20	0.75	-
ER2594	0.03	1.0	2.5	0.03	0.02	24.0-27.0	8.0-10.5	2.5-4.5	0.20-0.30	1.5	W: 1.0
ER410NiMo	0.06	0.5	0.6	0.03	0.03	11.0-12.50	4.0-5.0	0.4-0.7	-	0.75	-

SFA/AWS A5.14: SPECIFICATION FOR NICKEL AND NICKEL ALLOY BARE WELDING ELECTRODES AND RODS (EXTRACT)

Example: OK Autrod NiCrMo-13:

SFA/AWS A5.14: ERNiCrMo-13

ER NiCrMo-13

Symbol for the product:

ER = Solid wires (electrodes or rods)

EQ = Strip electrodes

Symbol for the chemical composition of strip, wire or rod. (Box 1.)

AWS Classification	C	Si	Mn	P	S	Cr	Ni	Mo	Nb	Cu	Fe
ERNiCr-3	0.1	0.5	2.5-3.5	0.03	0.015	18.0-22.0	min. 67.0	-	2.0-3.0	0.5	3.0
ERNiCrMo-3	0.1	0.5	0.5	0.02	0.015	20.0-23.0	min. 58.0	8.0-10.0	3.15-4.15	0.5	5.0
ERNiCrMo-4	0.02	0.08	1.0	0.04	0.03	14.5-16.5	Bal.	15.0-17.0	-	0.5	4.0-7.0
ERNiCrMo-13	0.01	0.1	0.5	0.015	0.010	22.0-24.0	Bal.	15.0-16.5	-	0.5	1.5

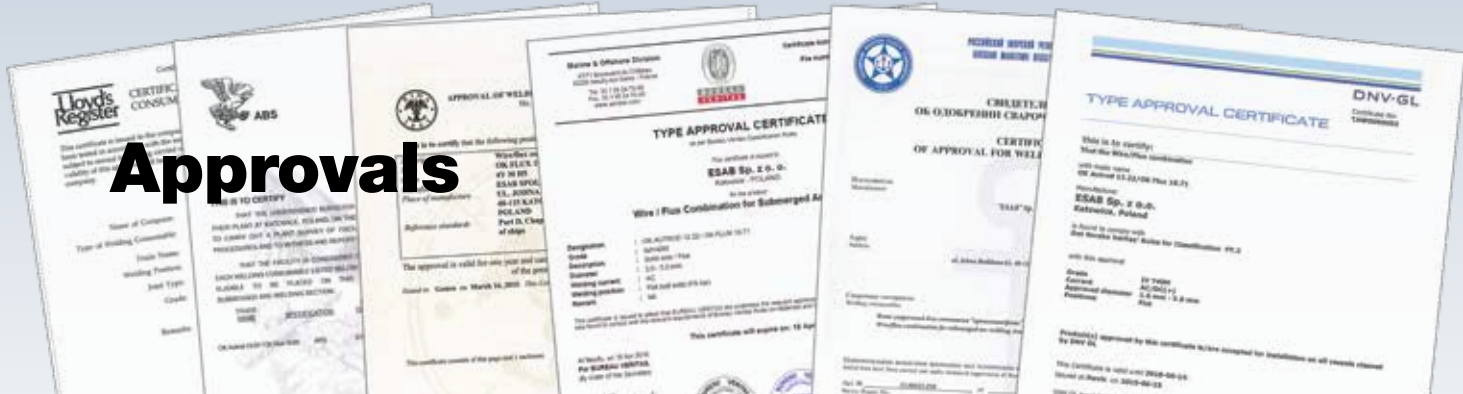

Approvals

Approvals from marine societies (Unified rules for major marine societies such as ABS, BV, DNV-GL, LR, RINA, RS)
 Normal and higher strength hull structural steels:

Grade of welding consumables (see notes)	A	B	D	E	A32/36	D32/36	E32/36	F32/36	A40	D40	E40	F40
1	x											
1Y	x				x (1)							
2	x	x	x									
2Y	x	x	x		x	x						
2Y40	(2)	(2)	(2)		x	x			x	x		
3	x	x	x	x								
3Y	x	x	x	x	x	x	x					
3Y40	(2)	(2)	(2)	(2)	x	x	x		x	x	x	
4Y	x	x	x	x	x	x	x	x				
4Y40	(2)	(2)	(2)	(2)	x	x	x	x	x	x	x	x

- (1): When joining higher strength steels using Grade 1Y welding consumables, the material thickness should not exceed 25 mm.
- (2): The welding consumables approved for steel Grades A40, D40, E40 and/or F40 may also be used for welding of the corresponding grades of normal strength steels subject to the special agreements with the Classification Society.

High strength quenched and tempered steels:

Grade of welding consumables	Steel Grades covered
3Y42	A - D 36, A - D 40, A - D 42
3Y46	A - D 40, A - D 42, A - D 46
3Y50	A - D 42, A - D 46, A - D 50
3Y55	A - D 50, A - D 55
3Y62	A - D 55, A - D 62
3Y69	A - D 62, A - D 69
4Y42	A - E 36, A - E 40, A - E 42
4Y46	A - E 40, A - E 42, A - E 46
4Y50	A - E 42, A - E 46, A - E 50
4Y55	A - E 50, A - E 55
4Y62	A - E 55, A - E 62
4Y69	A - E 62, A - E 69
5Y42	A - F 36, A - F 40, A - F 42
5Y46	A - F 40, A - F 42, A - F 46
5Y50	A - F 42, A - F 46, A - F 50
5Y55	A - F 50, A - F 55
5Y62	A - F 55, A - F 62
5Y69	A - F 62, A - F 69

Temperatures for approval grades

grade	temperature
2	0°C
3	-20°C
4	-40°C
5	-60°C
(6)	-60°C formely: GL, only)

Additional letters

T	Approved for two-run-technique (one run from each side)
M	Approved for multi-run technique
TM	Approved for two-run-technique (one run from each side) and for multi-run technique
H15, H10, H5	Low hydrogen approved, confirming to standard weld metal containing not more than 15, 10, 5 ml of hydrogen in 100 g of weld metal deposit.

DECLARATION OF PERFORMANCE

1. Unique identification code of the product-type: OK Flux 10.71 / OK Autrod 12.22 - EN ISO 14171-A: S 38.4 AB S28

2. Type, batch or serial number or any other element allowing identification of the construction product as required pursuant to Article 11(4): Flux wire combination, with flux no starting with: 1071 and 1222

3. Intended use or uses of the construction product, in accordance with the applicable harmonized technical specification, as foreseen by the manufacturer: Welding consumable used in metallic structures or in composite metal and concrete structures.

4. Name, registered trade name and contact address of the manufacturer as required pursuant to Article 11(5): ESAB, ESAB AB, Box 8504, SE-402 17 Göteborg, Sweden

5. Where applicable, name and contact address of the authorized representative whose mandate covers the tasks specified in Article 12(2): NA

6. System or systems of assessment and verification of constancy of performance of the construction product as set out in Annex V: System 2+

7. In case of the declaration of performance concerning a construction product covered by a harmonized standard: Notified factory production control certification body number 0202 - TÜV Rheinland Industrie Service GmbH, Cologne, Germany - performed the initial inspection of the manufacturing plant and of factory production control and the continuous surveillance, assessment and evaluation of factory production control and issued the certificate of conformity of the factory production control. Certificate no: 0035-CPD-C100

8. In case of the declaration of performance concerning a construction product for which a European Technical Assessment has been issued: NA

Essential characteristics (EN 13479:2004)	Performance	Harmonized technical specification
Tensile strength	Passed	EN 13479:2004, EN ISO 544:2011, EN ISO 14174:2012
Elongation	220%	EN 13479:2004, EN ISO 14171:2010
Tensile strength	3470 MPa, 2600 MPa	EN 13479:2004, EN ISO 14171:2010
Yield strength	2380 MPa	EN 13479:2004, EN ISO 14171:2010
Impact toughness	347 J, 489 J	EN 13479:2004, EN ISO 14171:2010
Chemical composition	Passed	EN 13479:2004, EN ISO 14171:2010
Durability	Passed	EN 13479:2004
Electrode classification	Passed	EN 13479:2004
Emission of radioactivity	is not relevant	EN 13479:2004

*) See the individual products' Safety Data Sheets available at www.esab.com

Other approvals

HARC
 НАЦИОНАЛЬНОЕ АГЕНТСТВО КОМПЕТЕНЦИИ СВАРКИ
 СВИДЕТЕЛЬСТВО
 № АИСМ-45 00064
 на аттестацию сварочных материалов в соответствии с требованиями ГОСТ 30413-01
 Производитель: ESAB Sp. z o.o., Poland
 (с аттестацией на соответствие требованиям ГОСТ 30413-01)

CANADIAN WELDING BUREAU
 Effective Date: March 30, 2015
CERTIFICATION OF WELDING CONSUMABLE
 This is to advise you the Canadian Welding Bureau has witnessed tests on the following:
 Company Name: ESAB AB
 Electrode Designation: OK AUTROD 12.22
 Point of Manufacture: Vantberg, Czech Republic
 Standard: CSA W48-14
 Classification: F69A6-EM12K
 Gas or Flux: OK Flux 10.72 (made in Poland)
 Size (mm): Min. - Max. 4 MM
 Expiry date: March 30, 2017
 This certification, may be extended by meeting the check test requirements of the applicable standard and CWB rules.
 ALICE Y. LAU, P. Eng
 Operations Manager, Procedures & Electrodes
 ATY
 ESABSP1222

Approval according to "Construction Production Regulation CPR" - CE-sign

Building materials, structural elements and constructions (also pre-fabricated) which are permanently installed into structural works from structural and civil engineering and which are connected to the ground are regulated according to CPR. For example, halls, cranes, bridges, lattice masts, chimneys and stacks.

UNRIVALED SERVICE AND SUPPORT.

Every ESAB product is backed by our commitment to superior customer service and support. Our skilled customer service department is prepared to quickly answer any questions, address problems, and help with maintenance and upgrading of your equipment. Our products are backed with the most comprehensive warranty in the business.

With ESAB, you can be sure that you have purchased equipment that will meet your needs today and in the future. Product and process training is also available. Ask your ESAB sales representative or distributor for a complete ESAB solution.

For more information visit esab.com.



Reg. No: XA00136020 / 09 2016 / Specifications subject to change without notice. Products may vary from those pictured.



ESAB / esab.com

